



Omnivision VHS

Panasonic

TV/DVD/VCR Combination Operating Instructions

Model No. PV-DF2700/PV-DF2000



Getting Started

Basic Operation

Advanced Operation

For Your Information



PV-DF2700



As an ENERGY STAR® Partner, Matsushita Electric Corporation of America has determined that this product or product model meets the ENERGY STAR® guidelines for energy efficiency.



Please read these instructions carefully before attempting to connect, operate or adjust this product. Please save this manual. Spanish Quick Use Guide is included. (Guía para rápida consulta en español está incluida.)

LSQT0281A

For assistance, please call : 1-800-211-PANA(7262) or send e-mail to : consumerproducts@panasonic.com

Important Safeguards and Precautions

READ AND RETAIN ALL SAFETY AND OPERATING INSTRUCTIONS. HEED ALL WARNINGS IN THE MANUAL AND ON UNIT

INSTALLATION

1 POWER SOURCE CAUTION

Operate only from power source indicated on unit or in this manual. If uncertain, have your Electric Utility Service Company or Video Products Dealer verify your home power source.

2 POWER CORD PLUG

For safety, this unit has a polarized type plug (one wide blade), or a three-wire grounding type plug. Always hold the plug firmly and make sure your hands are dry when plugging in or unplugging the AC power cord. Regularly remove dust, dirt, etc. on the plug.

POLARIZED PLUG CAUTION:

The plug fits into outlet one way. If it cannot be fully inserted, try reversing it. If it still will not fit, have an electrician install the proper wall outlet. Do not tamper with the plug.

GROUNDING PLUG CAUTION:

The plug requires a three-noise grounding outlet. If necessary, have an electrician install the proper outlet. Do not tamper with the plug.

3 POWER CORD

To avoid unit malfunction, and to protect against electrical shock, fire or personal injury:

- Keep power cord away from heating appliances and walking traffic. Do not rest heavy objects on, or roll such objects over the power cord.
- Do not tamper with the cord in any way.
- An extension cord should have the same type plug (polarized or grounding) and must be securely connected.
- Overloaded wall outlets or extension cords is a fire hazard.
- Frayed cords, damaged plugs, and damaged or cracked wire insulation are hazardous and should be replaced by a qualified electrician.

4 DO NOT BLOCK VENTILATION HOLES

Ventilation openings in the cabinet release heat generated during operation. If blocked, heat build-up may result in a fire hazard or heat damage to cassettes or discs.

For your protection:

- Never cover ventilation slots while unit is ON, or operate unit while placed on a bed, sofa, rug, or other soft surface.
- Avoid built-in installation, such as a book case or rack, unless properly ventilated.

5 PLACEMENT AVOID EXTREMELY HOT LOCATIONS OR SUDDEN TEMPERATURE CHANGES

Do not place unit over or near a heater or regulator, in direct sunlight, inside closed vehicles, in high temperature [over 95 °F (35 °C)], or in over 75% humidity. If unit is suddenly moved from a cold place to a warm one, moisture may condense in unit and on the tape causing damage. Never subject unit to vibration, impact, or place it so that the surface is tilted as internal parts may be seriously damaged.

6 TO AVOID PERSONAL INJURY

- Never place unit on support or stand that is not firm, level, and adequately strong. The unit could fall causing serious injury to a child or adult and damage to the unit.
- Move any appliance and cart combination with care. Quick stops, excessive force, and uneven surfaces may cause objects to overturn.
- Carefully follow all operating instructions.



OUTDOOR ANTENNA INSTALLATION

1 SAFE ANTENNA AND CABLE CONNECTION

An outside antenna or cable system must be properly grounded to provide some protection against built up static charges and voltage.

Section 810 of the National Electrical Code, ANSI/NFPA 70 (in Canada, part 1 of the Canadian Electrical Code) provides information regarding proper grounding of the mast and supporting structure, grounding of the lead-in wire to an antenna discharge unit, size of grounding conductors, location of antenna discharge unit, connection to grounding electrodes, and requirements for the grounding electrode.

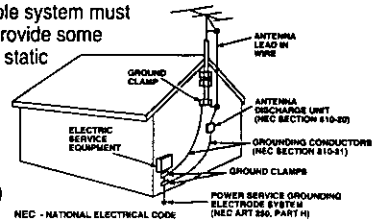

2 KEEP ANTENNA CLEAR OF HIGH VOLTAGE POWER LINES OR CIRCUITS

Locate an outside antenna system well away from power lines and electric light or power circuits so it will never touch these power sources should it ever fall. When installing antenna, absolutely never touch power lines, circuits or other power sources as this could be fatal.

USING THE UNIT

Before unit is brought out of storage or moved to a new location, refer again to the INSTALLATION section of these safeguards.

1 KEEP UNIT WELL AWAY FROM WATER OR MOISTURE, such as vases, sinks, tubs, etc.

2 IF EXPOSED TO RAIN, MOISTURE, OR STRONG IMPACT, unplug unit and have it inspected by a qualified service technician before use.

3 ELECTRICAL STORMS

During a lightning storm, or before leaving unit unused for extended periods of time, disconnect all equipment from the power source as well as the antenna and cable system.

4 WHEN UNIT IS PLUGGED IN

• DO NOT OPERATE IF:

- liquid has spilled into unit.
- unit was dropped or otherwise damaged.
- unit emits smoke, malodors, or noises.

Immediately unplug unit, and have it inspected by a service technician to avoid potential fire and shock hazards.

• Never drop or push any object through openings in unit.

- Touching internal parts may cause electric shock or fire hazard. Do not put any foreign object on the disc tray.
- Keep magnetic objects, such as speakers, away from unit to avoid electrical interference.

5 USING ACCESSORIES

Use only accessories recommended by the manufacturer to avoid risk of fire, shock, or other hazards.

6 CLEANING UNIT

Unplug unit. Use a clean, dry, chemically untreated cloth to gently remove dust or debris. DO NOT USE cleaning fluids, aerosols, or forced air that could over-spray, or seep into unit and cause electrical shock. Any substance, such as wax, adhesive tape, etc. may mar the cabinet surface. Exposure to greasy, humid, or dusty areas may adversely affect internal parts.

SERVICE

1 DO NOT SERVICE PRODUCT YOURSELF

If, after carefully following detailed operating instructions, the unit does not operate properly, do not attempt to open or remove covers, or make any adjustments not described in the manual. Unplug unit and contact a qualified service technician.

2 REPLACEMENT OF PARTS

Make sure the service technician uses only parts specified by the manufacturer, or have equal safety characteristics as original parts. The use of unauthorized substitutes may result in fire, electric shock, or other hazards.

3 SAFETY CHECK AFTER SERVICING

After unit is serviced or repaired, request that a thorough safety check be done as described in the manufacturer's service literature to insure video unit is in safe operating condition.

Safety Precautions/Mesures de sécurité

Warning: To prevent fire or shock hazard, do not expose this equipment to rain or moisture.

Caution: To prevent electric shock, match wide blade of plug to wide slot, fully insert.

Avertissement: Afin de prévenir tout risque d'incendie ou de chocs électriques, ne pas exposer cet appareil à la pluie ou à une humidité excessive.

Attention: Pour éviter les chocs électriques, introduire la lame la plus large de la fiche dans la borne correspondante de la prise et pousser jusqu'au fond.

This video recorder, equipped with the HQ (High Quality) System, is compatible with existing VHS equipment. Only use those tapes with the **VHS** mark. It is recommended that only cassette tapes that have been tested and inspected for use in 2, 4, 6, and 8 hour VCR machines be used.

This television receiver provides display of television closed captioning in accordance with §15.119 of the FCC rules.

FCC WARNING: Any unauthorized changes or modifications to this equipment would void the user's authority to operate.

CAUTION:

UNIT IS A CLASS I LASER PRODUCT.

HOWEVER THIS UNIT USES A VISIBLE LASER BEAM WHICH COULD CAUSE HAZARDOUS RADIATION EXPOSURE IF DIRECTED. BE SURE TO OPERATE THE UNIT CORRECTLY AS INSTRUCTED.

WHEN THIS UNIT IS PLUGGED TO THE WALL OUTLET, DO NOT PLACE YOUR EYES CLOSE TO THE OPENING OF THE DISC TRAY AND OTHER OPENINGS TO LOOK INTO THE INSIDE OF THIS UNIT.

USE OF CONTROLS OR ADJUSTMENTS OR PERFORMANCE OF PROCEDURES OTHER THAN THOSE SPECIFIED HEREIN MAY RESULT IN HAZARDOUS RADIATION EXPOSURE.

DO NOT OPEN COVERS AND DO NOT REPAIR YOURSELF. REFER SERVICING TO QUALIFIED PERSONNEL.

CAUTION:

LASER RADIATION WHEN OPEN.
DO NOT STARE INTO BEAM.

ATTENTION:

RAYONNEMENT LASER EN CAS
D'OUVERTURE.
NE PAS REGARDER DANS LE
FAISCEAU.

(Inside of product)

FCC NOTE:

This equipment has been tested and found to comply with the limits for a Class B digital device, pursuant to part 15 of the FCC Rules. These limits are designed to provide reasonable protection against harmful interference in a residential installation. This equipment generates, uses and can radiate radio frequency energy and, if not installed and used in accordance with the instructions, may cause harmful interference to radio communications. However, there is no guarantee that interference will not occur in a particular installation. If this equipment does cause harmful interference to radio or television reception, which can be determined by turning the equipment off and on, the user is encouraged to try to correct the interference by one of the following measures:

- Reorient or relocate the receiving antenna.
- Increase the separation between the equipment and receiver.
- Connect the equipment into an outlet on a circuit different from that to which the receiver is connected.
- Consult the dealer or an experienced radio/TV technician for help.

FCC Caution: To assure continued compliance, (example- use only shielded interface cables when connecting to other devices.) Any changes or modifications not expressly approved by the party responsible for compliance could void the user's authority to operate this equipment.

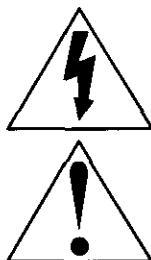

This symbol warns the user that uninsulated voltage within the unit may have sufficient magnitude to cause electric shock. Therefore, it is dangerous to make any kind of contact with any inside part of this unit.

This symbol alerts the user that important literature concerning the operation and maintenance of this unit has been included. Therefore, it should be read carefully in order to avoid any problems.

Region Management Information

Region Management Information: This unit is designed and manufactured to respond to the Region Management Information that is recorded on a DVD disc. If the Region number described on the DVD disc does not correspond to the Region number of this unit, this unit cannot play this disc.

The Region number
for this unit is 1.



Table of Contents

Getting Started

TV / VCR

Important Safeguards and Precautions	2
Before Using	6
Connections	9
One Time Setup	12

Basic Operation

TV / VCR

Reset Language, Channels, Clock	14
TV Operation	15
MTS Broadcast / TV Stereo System	16
Playback a Tape	17
Record On a Tape	18
Copy Your Tapes (Dubbing)	19

DVD

Basic DVD Operation	20
---------------------------	----

Advanced Operation

TV / VCR

Timer Recording	22
Timer Programming using VCR Plus+® System	24
Cable Box Universal Remote Control Feature	28
Picture in Picture (PIP) Operation (For Model PV-DF2700 only)	30
Closed Caption System	32
FM Radio	34
TV Timer Features	36
VCR Status & Clock Display	37
V-Chip Control Feature	38
Tape Operation	42
Special VCR Features	45
Audio Features	46
Audio / Video Menu	48
Audio / Video Adjustment	49

DVD

Disc Operation	50
DVD Operation using On-Screen Displays	55
DVD Lock Feature	58

For Your Information

TV / VCR

Before Requesting Service	62
Warning and Instruction Displays	63
Spanish Quick Use Guide/Guía para rápida consulta	65
Location of Controls	72
Service Center List	75
Limited Warranty	Back Cover

DVD

Settings for DVD Operation	59
Language Code List	64

TV / VCR

A Accessories	6	P Phones	15
Audio Adjustment	49	Picture in Picture (PIP)	30, 31
Audio Features	46	Playback	17
Audio Auto Gain Control (AGC)	48	Program End Search	42
Audio Menu	48	Q Quality Picture	17
Audio Mode for FM Radio	35	R Rapid Tune	15
Audio Mode for Playback	46	Rec(ord)	18
Audio Mode for Recording	46	Record/Playback Speed Settings	6
Audio Mode for TV Viewing	16	Remote Control Buttons	72
Audio Mute	15	Remote Warning ON/OFF	29
Audio / Video Adjustment	49	Repeat Play	42
Audio / Video Menu	48	Reset Language, Channels, Clock	14
Auto Operation Functions	44	Reset unit	8
B Batteries	6	Reverse Search	17
Before Requesting Service	62	Rewind	17
Before Using	6	S Secret Code	38
Blocking Message	41	Service Center List	75
Blue Screen Display	37	SELF-DEMO Mode	15
Broadcast Types	16	Sleep Timer	36
C Cable Box Setup	25	Slow Motion	17
Cable Box Universal Remote Control Feature	28	Spanish Quick Use Guide	65
Caption On Mute	33	Speaker ON/OFF	47
Channel	12, 14, 37	Special VCR Features	45
Clock	14	Specifications	8
Closed Caption	32	Still Picture	17
Code Numbers, DSS / Cable Box Brand	29	STOP	17
Commercial Skip	42	Surround Sound	47
Connections	9	SWAP Picture	31
Connections, Audio	10	T Tape Erasure Prevention	6
Connections, DSS / Cable Box	9	Time Zone Adjust	13
Connections, Outdoor Antenna	9	Timer Programming using VCR Plus+ System	24
Copy Your Tapes (Dubbing)	19	Timer Program Review, Replace, Clear	23
D DST. (Daylight Saving Time)	8	Timer Recording	22
E Eject tape	17	Timer Recording Cancellation	23
F Fast Forward	17	TV Operation	15
FM Radio	34, 35	TV Timer Features	36
Forward Search	17	U Unit, Front/Rear view	73, 74
Frame by Frame Advance	17	Universal Remote Control	28
Front Panel Indicators	74	US MOVIES/TV PROGRAMS Ratings	39, 40
Function Display	37	V VCR Lock	45
H Head Cleaning	7	VCR Plus+ System	24
I Important Safeguards and Precautions	2	VCR Status & Clock Display	37
Index Search	43	Video Adjustment	49
Input Mode	18	Video Menu	48
L Language	12, 14	V-Chip Control Feature	38
Location of Controls	72	W Warning and Instruction Displays	63
M Move screen	30	Warranty	Back Cover
MTS Broadcast / TV Stereo System	16	Weak Signal Display ON/OFF	45
O 100 Key	15	Z Zero Search	44
One Time Setup	12		
One Touch Recording	18		
ON-TIMER with Alarm	36		

DVD

A Auto-Power Off function	21	M Multiple angle viewing (DVD)	51
AUDIO OUTPUT	60	P Picture Zoom (DVD)	51
Audio soundtrack language (DVD)	50	Playback	20
B Basic DVD Operation	20	Playback control (Video CDs)	21
D Definition of terms	7	Program Play (Video CD/CD)	53
Disc Audio attribute 1 type, sampling frequency, bit No.	50	R Random Play (Video CD/CD)	54
Disc handling	7	Rapid Advance/Reverse	21
Disc information screen	56	Repeat Play	57
DISC LANGUAGES (DVD)	59	RESUME function	21
Disc Operation	50	S Settings for DVD Operation	59
DVD Lock Feature	58	Skip a Chapter/Track	21
DVD Lock Ratings (DVD)	58	Slow Motion (DVD/Video CD)	21
DVD menu (DVD)	52	STILL MODE	61
DVD Operation using On-Screen Displays	55	Still Picture	21
F Frame by Frame Advance (DVD/Video CD)	21	Subtitle language (DVD)	50
K Karaoke (DVD/Video CD)	51	T TV MODE	61
L Language Code List	64	Title menu (DVD)	52
		U Unit information screen (Unit)	57

Before Using

Congratulations

on your purchase of one of the most sophisticated and reliable products on the market today. Used properly, it will bring you and your family years of enjoyment. Please fill in the information below. The serial number is on the tag located on the back of your unit.

Date of Purchase _____
 Dealer Purchased From _____
 Dealer Address _____
 Dealer Phone No. _____
 Model No. _____
 Serial No. _____

Accessories

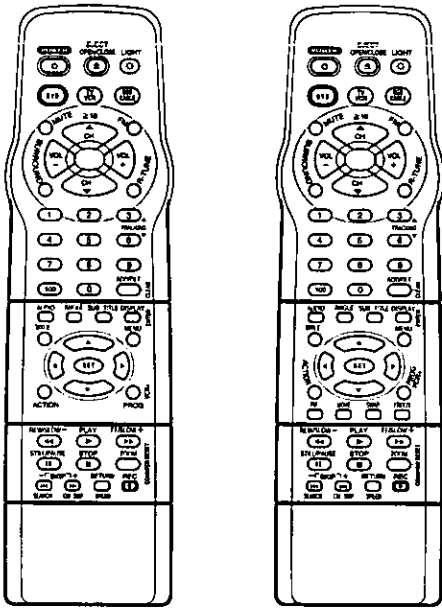

- Remote Control LSSQ0246 (PV-DF2000) Remote Control LSSQ0245 (PV-DF2700)

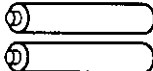
- Batteries 2 "AA" 

Record/Playback Time

Only use tapes with the **VHS** mark in this unit.

Tape Speed Setting	Type of Video Cassette		
	T60	T120	T160
SP (Standard Play)	1 Hour	2 Hours	2 Hours 40 Minutes
LP (Long Play)	2 Hours	4 Hours	5 Hours 20 Minutes
SLP (Super Long Play)	3 Hours	6 Hours	8 Hours

SELF-DEMO Mode

If **SELF-DEMO** screen is displayed when Power is turned ON, hold down **PLAY/REPEAT** on the unit for 5 seconds to deactivate the **SELF-DEMO** Mode.

Repeat this to display demo screen.

Loading the Batteries

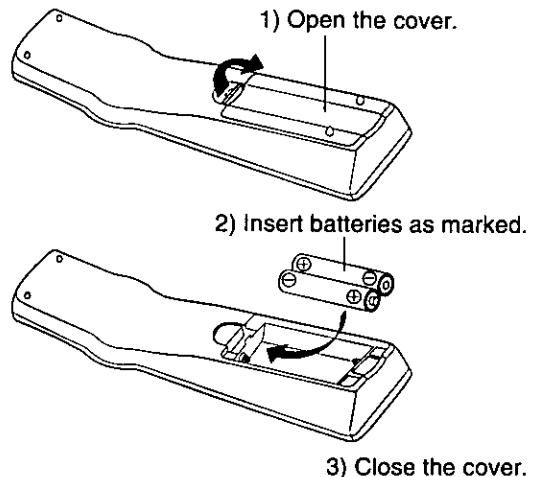

- Battery replacement caution**
- Do not mix old and new batteries.
 - Do not mix alkaline with manganese batteries.

Prevent Accidental Tape Erasure

Break off the rec. tab.

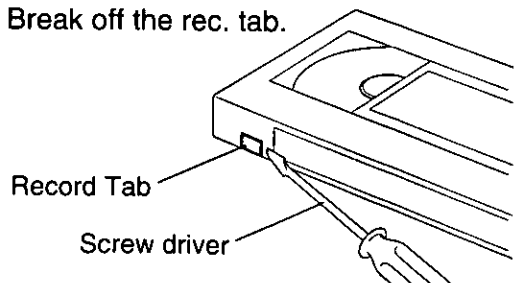

To record again.

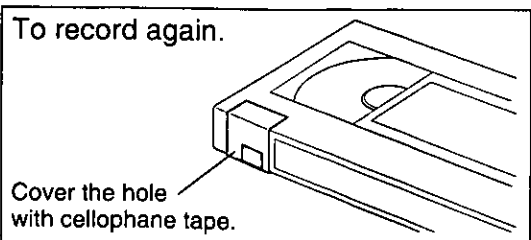

Disc formats supported by this unit

The unit can play back discs bearing any of the following marks:



DVD

3" (8 cm) disc / 5" (12 cm) disc



Video CD

3" (8 cm) disc / 5" (12 cm) disc



CD

3" (8 cm) disc / 5" (12 cm) disc

Discs which cannot be played with this unit

- DVD with Region No. other than "1" or "ALL"
- DVD of PAL system
- DVD-ROM
- DVD-R/DVD-RAM
- CD-ROM
- CDV
- CD-G
- CD-RW
- Do not try to play Photo CD or CD-R.



is registered trademark.

Definition of terms

Angle

Some DVD discs feature scenes simultaneously shot from different angles. The ANGLE button can be used to view the scene from different angles. (ANGLE indicator lights on the unit when a scene recorded at different angles is detected.)

Chapter number

Titles are subdivided into numbered sections. You can quickly search for a favorite scene using these numbers.

DVD

A high-density optical disc on which high-quality pictures and sound have been digitally recorded. DVD incorporates new video compression technology (MPEG II) and high-density recording technology which allow entire movies to be recorded with incredible playback quality.

Playback control

With Video CD (version 2.0), scenes or information may be selected for viewing or listening from an interactive menu that appears on the TV screen.

Subtitles

Written dialogue which appears at the bottom of the screen.

Time number

The elapsed play time from the start of a disc or title. Use to quickly find scenes. (May not work with some discs.)

Title number

For DVD discs with two or more titles, the title is numbered as title 1, title 2, etc.

Track number

Numbers assigned to tracks on Video CDs and CDs to allow specific tracks to be quickly located.

Video CD

CD containing picture and sound with same quality level as video tape. This unit also supports Video CDs with playback control (version 2.0).

Disc handling

Handling precautions

- Only hold disc by edges as shown. Fingerprints, dirt, and scratches can cause skipping and distortion.
- Do not write on label side of disc.
- Never use record cleaning sprays, benzine, thinner, static electricity prevention liquids, or any other solvent.
- Be careful not to drop or bend disc.
- Do not place more than 1 disc on disc tray.
- Do not try to close disc tray when disc is not properly placed.
- Always store discs in their proper cases when not in use.

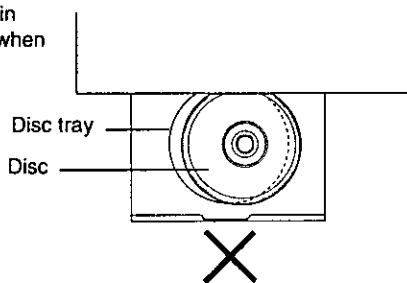
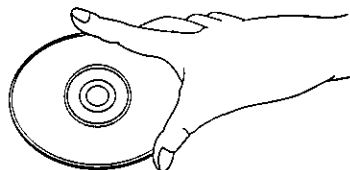
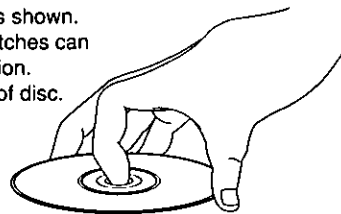

To clean disc surface

With a soft, damp (water only) cloth, gently wipe from the center hole to the outer edge as shown below. (Wiping in a circular pattern will scratch the surface.)

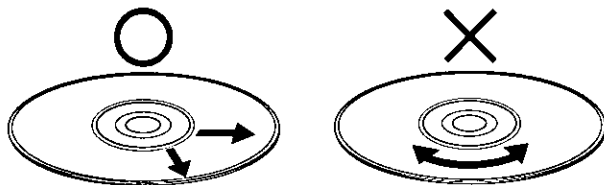

If disc is brought from a cold to a warm environment, moisture may form on the disc

Wipe away moisture with a soft, dry, lint-free cloth before using disc. (See above.)

Improper disc storage

Discs could be damaged if stored or left in areas:

- exposed to direct sunlight.
- that are humid or dusty.
- near heat (i.e. heater, regulator, etc.).

Apparatus Claims of U.S. Patent Nos. 4,631,603, 4,577,216, and 4,819,098, licensed for limited viewing uses only.

This product incorporates copyright protection technology that is protected by method claims of certain U.S. Patents and other intellectual property rights owned by Macrovision Corporation and other rights owners. Use of this copyright protection technology must be authorized by Macrovision Corporation, and is intended for home and other limited viewing uses only unless otherwise authorized by Macrovision Corporation. Reverse engineering or disassembly is prohibited.

Before Using (continued)

Reset all unit Memory Functions

Use when moving unit to a new location, or if a mistake was made in the One Time Setup section.

- Make sure a tape is not inserted in the unit.

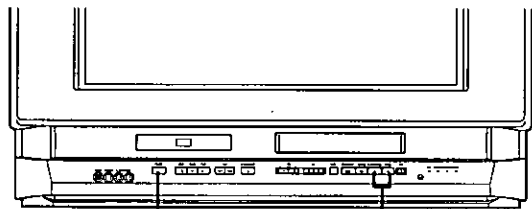

- 1 Turn the unit Power on.
- 2 Press and hold both **FF** and **PLAY** on the unit for more than 5 seconds.
 - The power will shut off.
- 3 Do "One Time Setup" steps on page 12.

DST. (Daylight Saving Time)

Unit auto adjusts clock for DST (Daylight Saving Time).

Spring (First Sunday in April)

DST:ON → Sets clock ahead one hour.

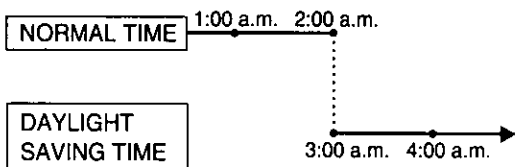

Autumn (Last Sunday in October)

DST:ON → Turns clock back one hour.

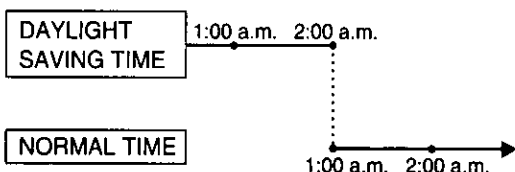

- If your area does not observe Daylight Saving Time, select DST : OFF (see page 14.)
- Keep these time changes in mind when programming the unit for timer recordings.

Head Cleaning

Playing older or damaged tapes may eventually cause video heads to become clogged.

Head Clog Sensor

During playback this screen appears if clogging is detected. To remove screen, press **PLAY** on the remote or unit.

- Use "dry" type head cleaning cassette only.

(Part No. NV-TCL30PT is recommended.)

- Follow cleaning tape directions carefully. Excessive use of head cleaning tape can shorten the video head life.

- If head clog symptoms persist, contact your nearest Factory Service Center or authorized Service Center. (See page 75.)

VIDEO HEADS MAY
NEED CLEANING
PLEASE INSERT HEAD
CLEANING CASSETTE
OR REFER TO MANUAL

END:PLAY

Specifications

Display

Picture Tube: 27 inch diagonal PureFlat™ Picture Tube (PV-DF2700)
20 inch diagonal PureFlat™ Picture Tube (PV-DF2000)

VCR

Video Recording System: 4 rotary heads helical scanning system
Audio Track: 1 track (Normal)
2 channel (Hi-Fi Audio Sound)

Tuner

Broadcast Channels: VHF 2 ~ 13, UHF 14 ~ 69
CABLE Channels: Midband A through I (14 ~ 22)
Superband J through W (23 ~ 36)
Hyperband AA ~ EEE (37 ~ 64)
Lowband A-5 ~ A-1 (95 ~ 99)
Special CABLE channel 5A (01)
Ultraband 65 ~ 94, 100 ~ 125

FM Radio

Band range: 87.5 ~ 108.1 MHz

General

Power Source: 120V AC, 60 Hz

Power Consumption:

Power On

Approx. 174 watts (PV-DF2700)

Approx. 128 watts (PV-DF2000)

Power Off

Approx. 4.5 watts

Television System:

EIA Standard NTSC color

Speaker:

2 pieces

Operating Temperature:

5 °C ~ 35 °C (41 °F ~ 95 °F)

Operating Humidity:

10 % ~ 75%

Weight:

52.0 kg (114.6 lbs.) (PV-DF2700)

30.0 kg (66.1 lbs.) (PV-DF2000)

Dimensions:

760 (W) x 651 (H) x 503 (D) mm
29-15/16" (W) x 25-5/8" (H) x 19-3/4" (D)
(PV-DF2700)

604 (W) x 523 (H) x 503 (D) mm

23-3/4" (W) x 20-9/16" (H) x 19-3/4" (D)
(PV-DF2000)

Discs played

(1) DVD-VIDEO disc

5" (12 cm) single-sided, single-layer

5" (12 cm) single-sided, double-layer

5" (12 cm) double-sided, double-layer
(one layer per side)

3" (8 cm) single-sided, single-layer

3" (8 cm) single-sided, double-layer

3" (8 cm) double-sided, double-layer
(one layer per side)

(2) Compact disc

5" (12 cm) disc

(CD-DA, VIDEO CD)

3" (8 cm) disc

Digital audio output:

Optical connector

Optical digital output:

Wave length : 655 nm (DVD)

790 nm (Video CD/CD)

Pickup:

Laser power : CLASS II

Note: Designs and specifications are subject to change without notice.

Connections

Outdoor Antenna Connections

Unhook the antenna from your previous TV or VCR and connect it to the back of the unit as shown in the diagram.

If your antenna system has separate UHF and VHF lead-ins, you need a UHF/VHF Band Mixer (not supplied.)

WARNING:

When using "Nut type" RF coaxial cables, tighten with fingers only. Overtightening may damage terminals.

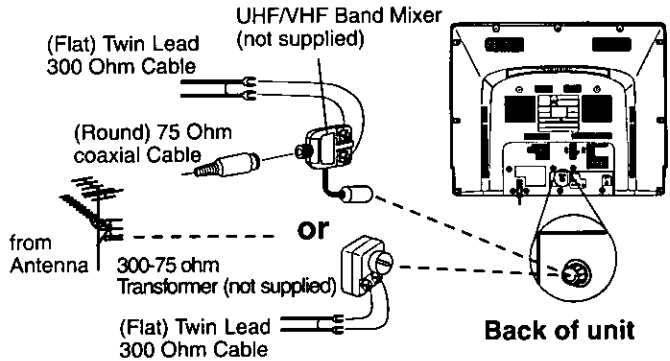

DSS/Cable Box Connections

Without a Cable Box

You can;

- record or view unscrambled channels.

You cannot;

- record or view scrambled channels.
- view a channel other than the one selected for any type of recording.

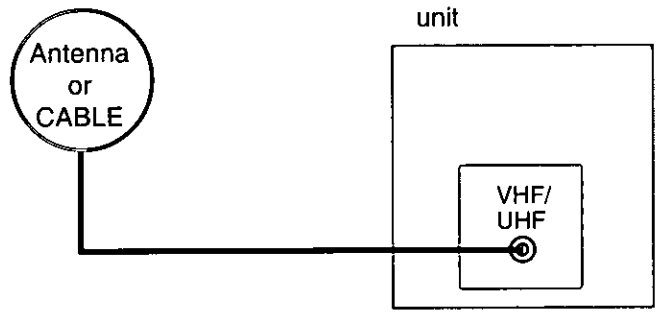

With a Cable Box

You can;

- record or view any channel including scrambled channels.

NOTE: Channel selection must be made at the cable box.

You cannot;

- view a channel other than the one selected for any type of recording.
- do a Timer recording of a channel unless you select it at the cable box.

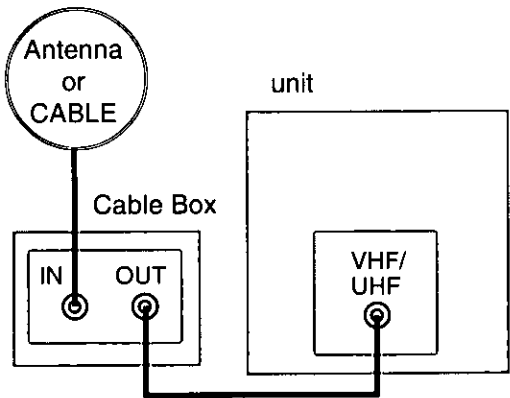

Note to CABLE System Installer

This reminder is provided to call the CABLE (Cable TV) System Installers attention to Article 820-40 of the NEC that provides guidelines for proper grounding and, in particular, specifies that the cable ground shall be connected to the grounding system of the building, as close to the point of cable entry as practical.

With a DSS Receiver

You can;

- record or view any channel including scrambled channels.

NOTE: Channel selection must be made at the DSS Receiver.

You cannot;

- view a channel other than the one selected for any type of recording.
- do a Timer recording of a channel unless you select it at the DSS box.

NOTE: The DSS receiver must be turned off to view programs from a cable box or antenna. See the DSS manual for details.

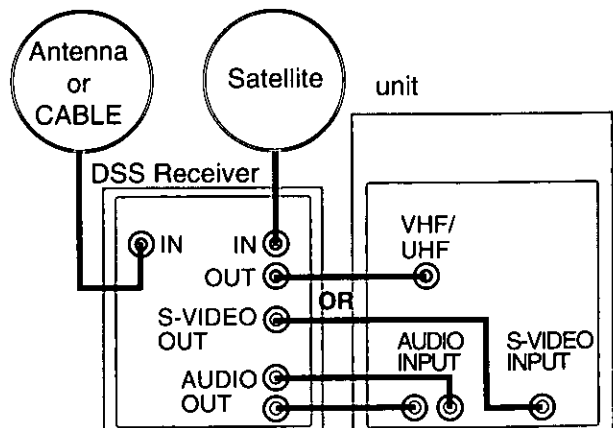

Connections (continued)

Audio connections

■ Unit → Amplifier → Speaker

Do the "Speaker ON/OFF system" steps on page 47, and select "OFF."

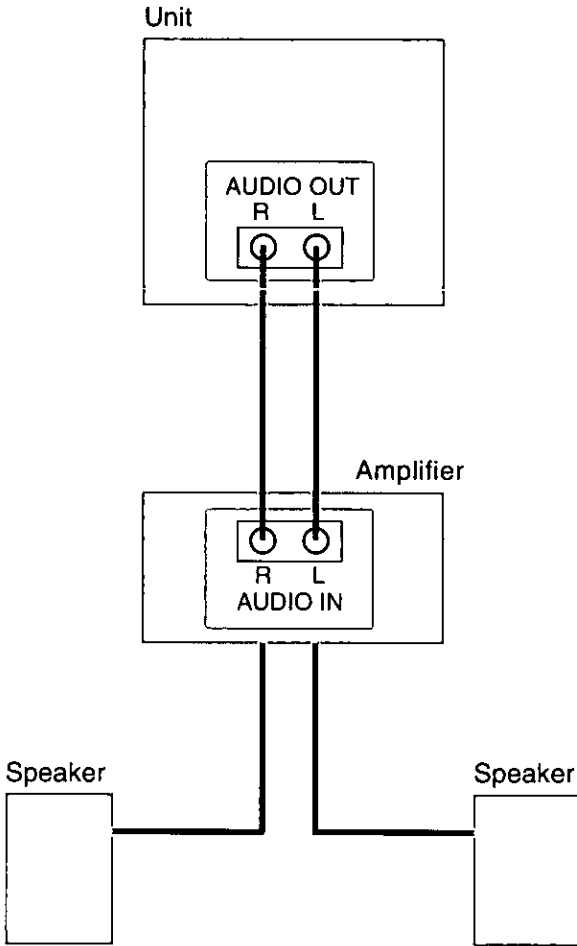

Check list before you begin.

- Turn down the volume, then turn this unit, as well as other equipment to be connected, off before proceeding with connection.
- Do not block ventilation holes of any of the equipment and arrange them so that air can circulate freely.
- Read through the instructions before connecting other equipment.
- Ensure that you observe the color coding when connecting audio and video cables.

Enjoying digital audio output from the digital audio output connector

Notes on audio output from the optical digital audio output connector

Disc	Sound recording format	Optical digital audio output from connector
DVD	Dolby Digital (AC-3)	Dolby Digital bitstream (2-5.1 ch) or OFF (no output)
	Linear PCM (48/96 kHz 16/20/24 bit)	Linear PCM (2ch) (48 kHz sampling/16 bit only)*2 or no output*1
	dts	Bitstream or no output*1
Video CD	MPEG 1	PCM (44.1 kHz sampling)
CD	Linear PCM	Linear PCM (44.1 kHz sampling)

*1 The type of audio output from the connector can be selected by the Settings for DVD Operation. (See page 60.)

*2 Sound having 96 kHz sampling is converted into 48 kHz sampling when it is output from the unit's optical digital audio output connector.

For your reference:

- Dolby Digital (AC-3) is a digital sound compression technique developed by the Dolby Laboratories Licensing Corporation. Supporting 5.1-channel surround sound, as well as stereo (2-channel) sound, this technique enables a large quantity of sound data to be efficiently recorded on a disc.
- Linear PCM is a signal recording format used in CDs. While CDs are recorded in 44.1 kHz/16 bit, DVDs are recorded in 48 kHz/16 bit up to 96 kHz/24 bit.
- If you have a Dolby Pro Logic Surround decoder, you will obtain the full benefit of Pro Logic from the same DVD movies that provide full 5.1 channel Dolby Digital soundtracks, as well as from titles with the Dolby Surround mark. Pro Logic Surround Sound Decoders please contact your local dealer.

Manufactured under license from Dolby Laboratories. "Dolby", "AC-3", "Pro Logic" and the double-D symbol are trademarks of Dolby Laboratories.
Confidential Unpublished Works. © 1992-1997 Dolby Laboratories, Inc. All rights reserved.

■ Unit → Decoder with Dolby Digital (AC-3) → Amplifier → Speaker or dts (digital theater systems)

When DVDs recorded in Dolby Digital or dts are played, Dolby Digital bitstream or dts bitstream is output from the unit OPTICAL digital audio output connector. When the unit is connected to a Dolby Digital decoder or dts decoder, you can enjoy theater-quality audio in your home. [An optical digital audio cable (optional) is required when an optional Dolby Digital decoder or dts decoder is used.]

Notes on connecting an optical digital audio cable (optional)

- Remove dust protection cap from optical digital audio output. Firmly connect the cable to the connector.
- Always reattach the dust protection cap when connector is not in use.

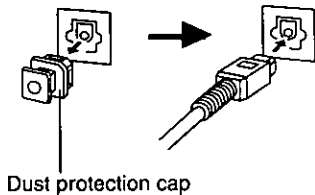

Caution for optical digital audio output connector:

- When connecting an amplifier (with an optical digital input connector) which does not contain the Dolby Digital (AC-3) or dts decoder, be sure to select "OFF" at "Dolby Digital" and "OFF" at "dts" of the Settings for DVD Operation "AUDIO OUTPUT" (see page 60).
- Otherwise any attempt to play DVDs may cause such a high level of noise that it may be harmful to your ears and damage your speakers.
- When a dts decoder is connected, please select "Bitstream" at "dts" of the Settings for DVD Operation "AUDIO OUTPUT". If "OFF" is selected, there will be no sound. (See page 60).
- Video CDs and CDs can be played as normal.

Note:

- Some dts decoders which do not support DVD-dts interface may not work properly with the unit.

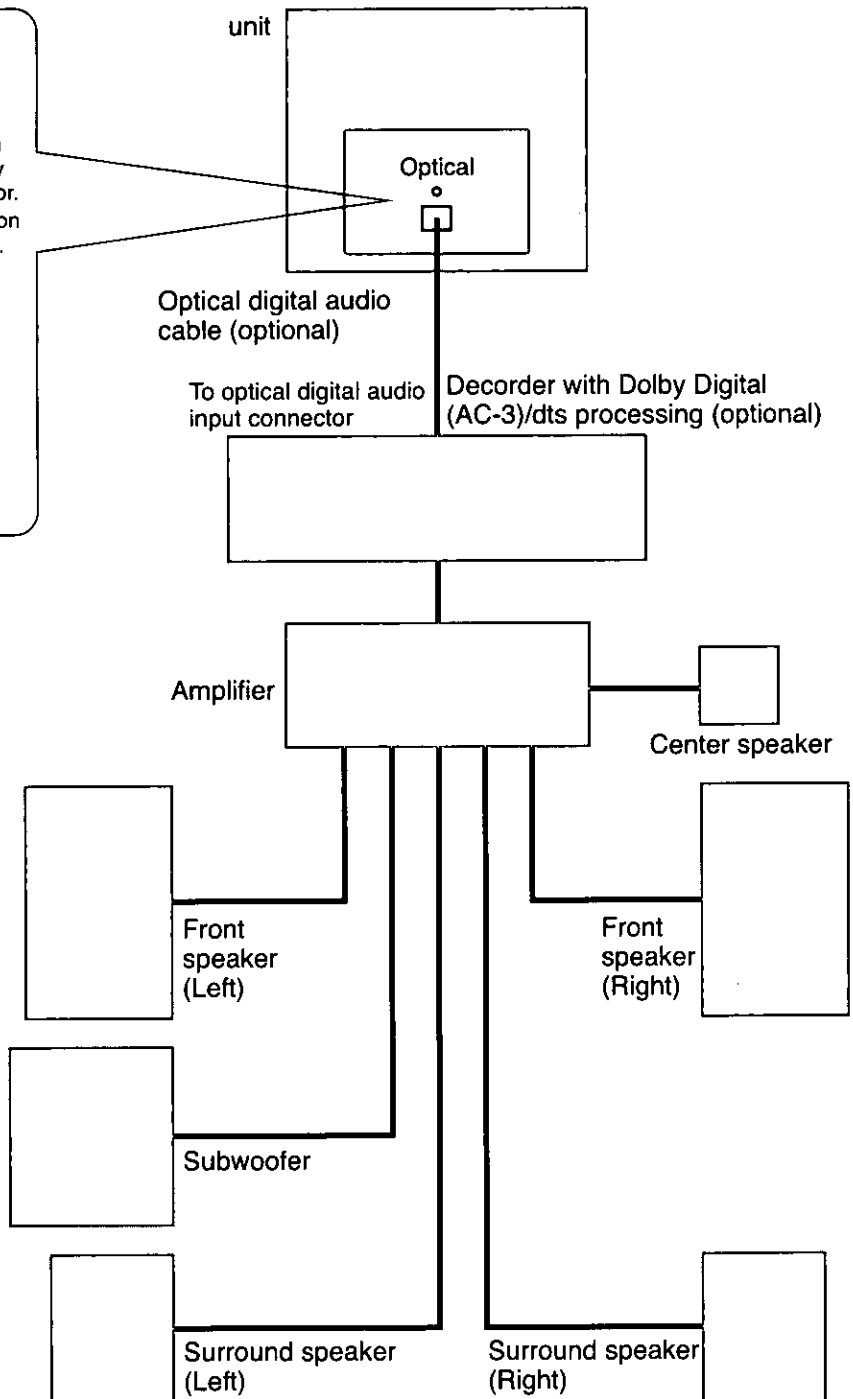

One Time Setup

When the unit is turned on the first time, setup mode is entered automatically.



Press **POWER*** on the remote or unit.

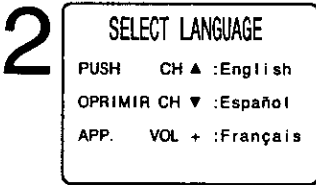

Select the language.

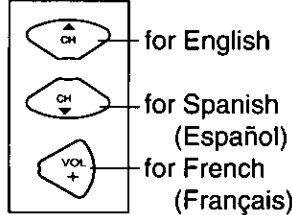

- If wrong language is set, complete "Reset all unit Memory Functions" steps page 8.
- If you use a cable box, it must be left on.

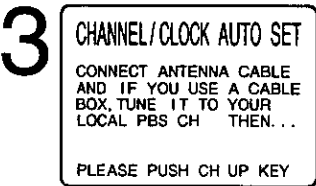

Start Channel Auto Set and Clock Auto Set.

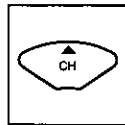

Press **CH ▲**.

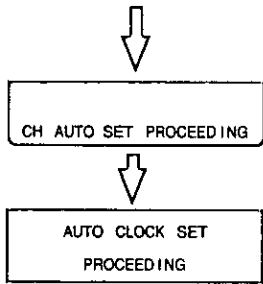

(Setup completed)

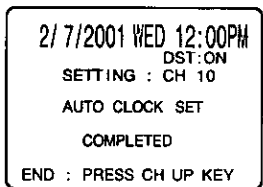

- If time is not correct... even though your area observes daylight saving time and DST is set to ON, do Time Zone Adjust steps on the next page.

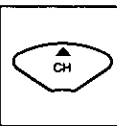

Press **CH ▲** to exit.

- If your area observes daylight saving time, but you would like to turn the DST feature off, complete the "To Set or Reset the Clock" steps on page 14 and set DST : OFF.

Process of Setup

Language ⇨ Channel ⇨ Clock

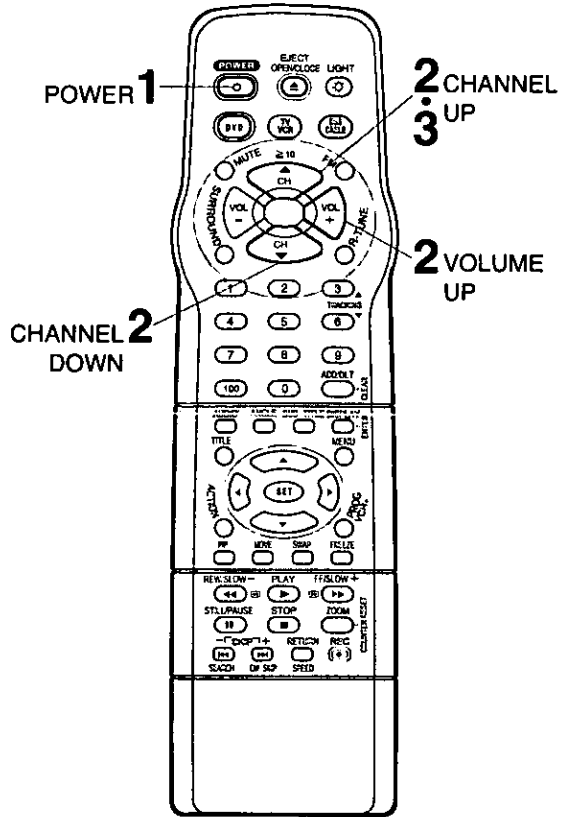

Model PV-DF2700 remote is shown here.

(Setup incomplete)

Case 1

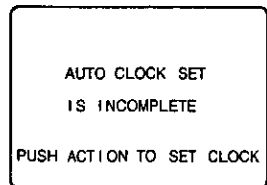

See Case 1 next page.

IMPORTANT NOTE FOR AUTO CLOCK SET

- Auto clock set is performed the first time the unit is turned off each day. If used, a cable box must be left on and tuned to the PBS channel at the time the unit power is turned off if you want auto clock set to be done.
- If using a DSS receiver, it must be turned off for auto clock set.
- If a Cable Box or DSS receiver is connected to the unit via Audio/Video Jacks, an RF coaxial cable must also be connected for auto clock set and channel auto set features.
- If for any reason the time is changed manually, automatic time correction will not occur.

Case 1 Clock Setup is Incomplete
Set the clock manually.

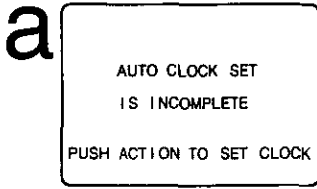

Display SET CLOCK screen.

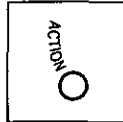

Press ACTION.

<Model PV-DF2700 button shown>

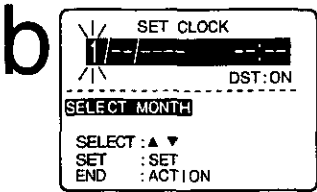

Set the clock manually.

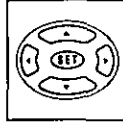

- 1) Press $\blacktriangle/\blacktriangledown$ to select the month.
- 2) Press SET to set.

• Likewise, set date, year, time, and DST (Daylight Saving Time).

To Make Corrections, repeatedly press $\blacktriangleleft/\blacktriangleright$ to move to error, then correct.

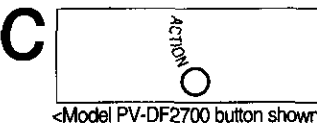

End setup.

Press ACTION twice (Clock starts.)

<Model PV-DF2700 button shown>

Time Zone Adjust (if necessary)

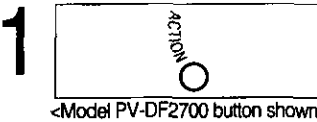

Display MAIN MENU.

Press ACTION.

<Model PV-DF2700 button shown>

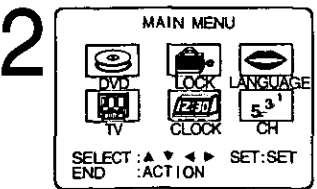

Display SET CLOCK screen.

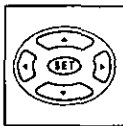

- 1) Press $\blacktriangle/\blacktriangledown/\blacktriangleleft/\blacktriangleright$ to select "CLOCK"
- 2) Press SET to display.

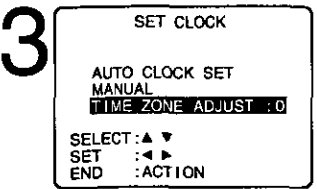

Select TIME ZONE ADJUST.

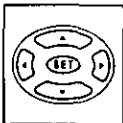

- 1) Press $\blacktriangle/\blacktriangledown$ to select.
- 2) Press $\blacktriangleleft/\blacktriangleright$ to subtract or add hour(s) as necessary.

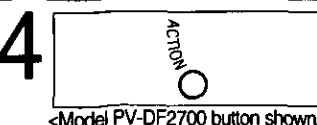

End setup.

Press ACTION twice.

• TIME ZONE ADJUST returns to "0" if clock is set manually.

<Model PV-DF2700 button shown>

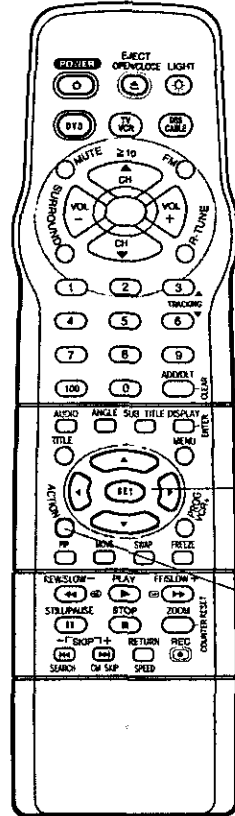

Model PV-DF2700 remote is shown here.

Notes

- Channel auto set selects normal TV or Cable channels depending on your unit hookup.
- The Language, Channel, and Clock settings can be changed at a later time (see page 14). To reset all of these settings, do the "Reset all unit Memory Functions" steps on page 8.
- This unit's calendar is accurately maintained up to Dec. 31, 2089, 11:59 PM.

Reset Language, Channels, Clock

To Change the OSD Language

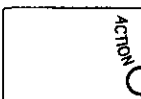
1  **Display MAIN MENU.**
Press ACTION*.
<Model PV-DF2700 button shown>

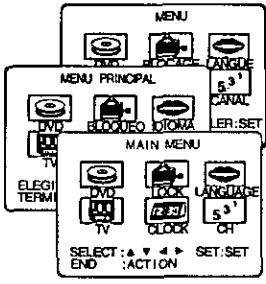
2  **Select the language selection icon.**
1) Press ▲▼◀▶ to select.
2) Press SET repeatedly to set.
English:LANGUAGE
Spanish:IDIOMA
French:LANGUE

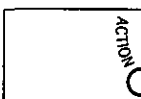
3  **End setup.**
Press ACTION to exit.
<Model PV-DF2700 button shown>

To Replace Channels in Memory

* It is necessary to enter TV mode by pressing $\sqrt{\text{TV}}$ before selecting "CH" on the MAIN MENU.

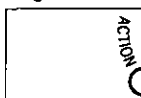
1  **Display MAIN MENU.**
Press ACTION.
<Model PV-DF2700 button shown>

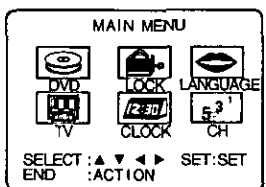
2  **Display SET UP CHANNEL screen.**
1) Press ▲▼◀▶ to select "CH."
2) Press SET to display.

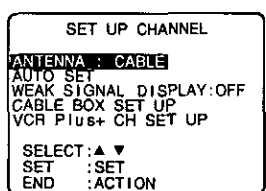
3  **Select ANTENNA.**
1) Press ▲▼ to select.
2) Press SET to select your antenna system ("TV" or "CABLE.")

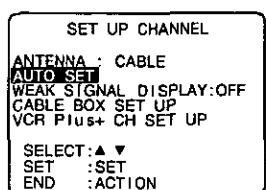
4  **Select AUTO SET.**
1) Press ▲▼ to select.
2) Press SET to start.

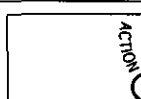
5  **End setup.**
Press ACTION twice.
<Model PV-DF2700 button shown>

To Set or Reset the Clock

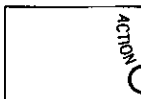
1  **Display MAIN MENU.**
Press ACTION.
<Model PV-DF2700 button shown>

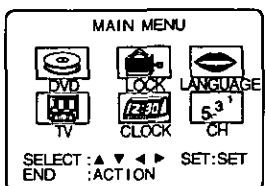
2  **Display SET CLOCK screen.**
1) Press ▲▼◀▶ to select "CLOCK."
2) Press SET.

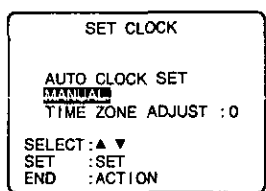
3  **Display SET CLOCK menu.**
1) Press ▲▼ to select "MANUAL."
2) Press SET to set.

* For Auto Clock Set, select "AUTO CLOCK SET" then press SET to set and CH ▲ to start.

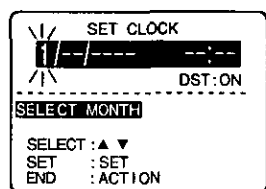
4  **Set the clock manually.**
1) Press ▲▼ to select the month.
2) Press SET to set.

* Likewise set date, year, time, and DST. (Daylight Saving Time.)

To Make Corrections, repeatedly press ◀▶ to move to error, then correct.

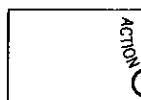
5  **End setup.**
Press ACTION twice to start the clock and exit this mode.
<Model PV-DF2700 button shown>

Add or Delete a Channel

To add channel:
Select channel with NUMBERED keys and press ADD/DLT.

CHANNEL 08 ADDED

To delete channel:
Select channel with CH ▲▼ or NUMBERED keys and press ADD/DLT.

CHANNEL 08 DELETED

TV Operation

•Important: If a remote control button does not work when pressed, press the button on the remote and try the button again.

Basic TV Operation

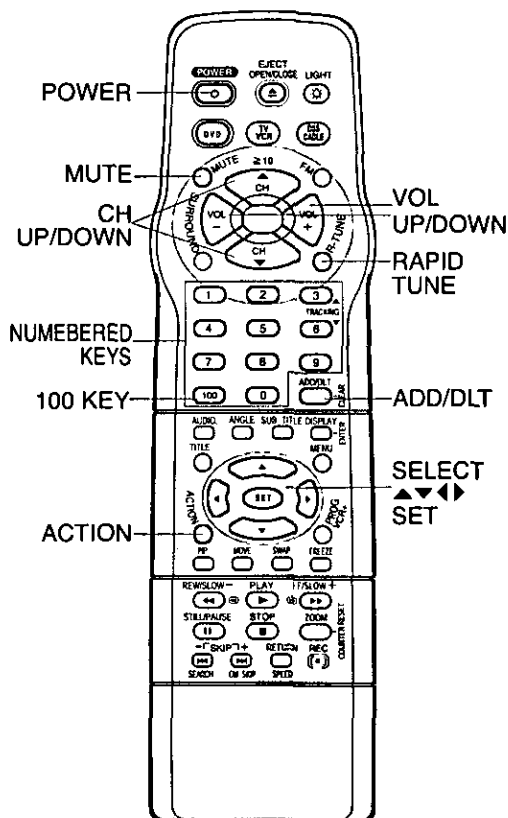
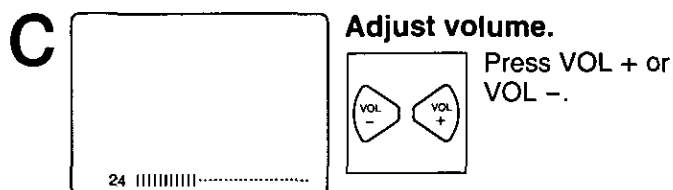
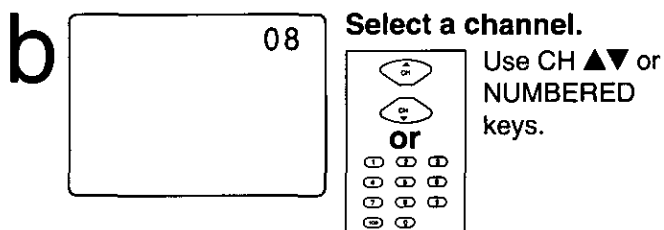
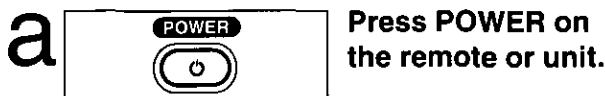

Model PV-DF2700 remote is shown here.

- Check list before you begin.**
- All connections are made. (See page 9.)
 - Your unit is plugged in.

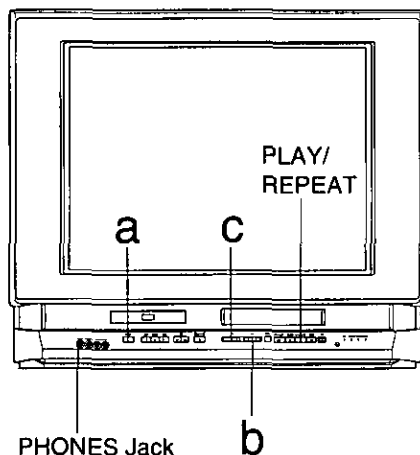

Basic Operation

■ Using the 100 key

When selecting CABLE channels 100 to 125 with the NUMBERED keys, first press the 100 key, and then enter the remaining two digits.

■ Rapid Tune

Press R-TUNE to display the last channel you were watching.

■ Audio Mute

Press MUTE to instantly mute the sound. Press again, to restore the previous sound level.

■ Phones

Connect an earphone (not supplied) or headphones (not supplied) to the Phones Jack.

MTS Broadcast / TV Stereo System

Receivable Broadcast Types

The following are possible broadcast types with their accompanying on-screen displays. The signal being received is indicated with a "▶" mark while the selected audio mode is indicated with an arrow. To change the audio mode for these broadcasts, follow the "Select Audio Mode for TV Viewing" section (below).

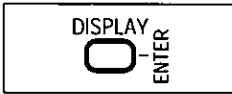

Display the broadcast signal being received.

Press DISPLAY* to display.

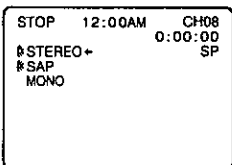

MTS Stereo and SAP broadcast

Multi-channel Television Sound Stereo (main language) and Secondary Audio Program (sub language) broadcasts are both being received simultaneously. Select the STEREO or SAP audio mode.

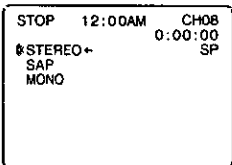

MTS Stereo broadcast

Multi-channel Television Sound Stereo broadcast. Select STEREO audio mode. • If stereo broadcast is weak and the display flickers, select MONO audio mode for possibly better results.

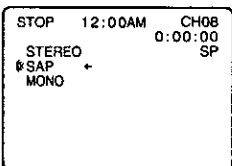

SAP broadcast

Secondary Audio Program (sub language.) Select SAP audio mode for the sub language.

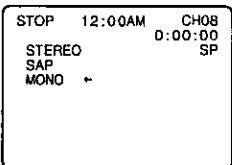

MONO broadcast

Normal monaural sound broadcast.

Select Audio Mode for TV Viewing



Press AUDIO to select the desired audio mode as described above.

(Arrow shows selection.)

- Each press of AUDIO will change the audio mode as shown below.
- "SAP" is selected with first press of AUDIO.

< Example >

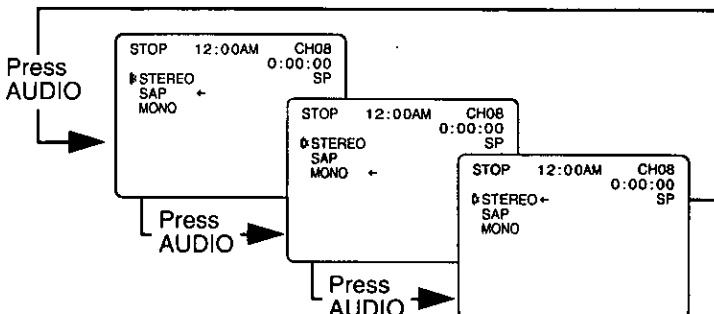

Equipped with dbx® -TV Noise Reduction for true MTS reproduction.

dbx® -TV Noise Reduction is required for good stereo separation and audio fidelity. dbx® is a registered trademark, and is licensed by dbx® Technology Licensing.

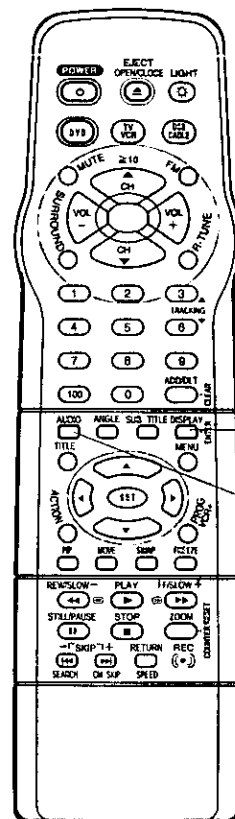

Model PV-DF2700 remote is shown here.

Notes <For Model PV-DF2700 only>

- Only TV audio from Main Picture is output.
- Audio mode can only be changed for the Main Picture.

Playback a Tape

• Important: if a remote control button does not work when pressed, press the **VCR** button on the remote and try the button again.

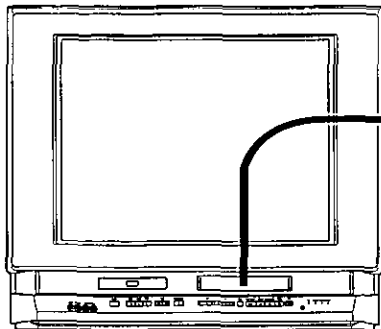

✓ Check list before you begin.

- All connections are made. (See page 9.)
- Your unit is plugged in.

1

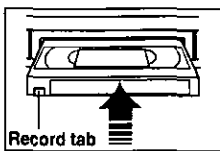

Insert a cassette.

- The unit power comes on automatically.

Note

To prevent tape jam

Inspect your cassette tapes and remove any loose or peeling labels.

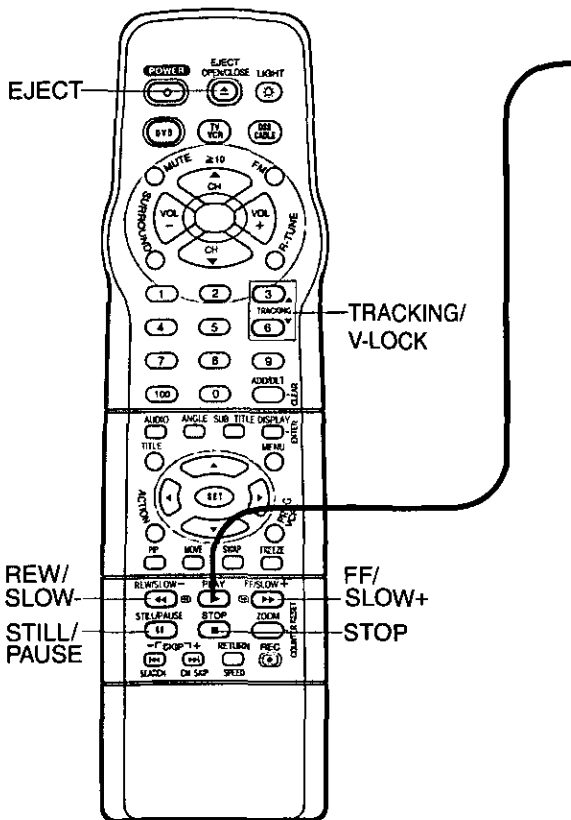
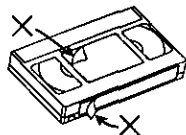

Model PV-DF2700 remote is shown here.

2



Press PLAY.

- Playback begins if cassette has no record tab (see page 6.)

■ To Find a Particular Scene

Forward Search → Press FF/SLOW+
(To release, press PLAY or FF)

Reverse Search → Press REW/SLOW-
(To release, press PLAY or REW)

■ To view a Still (Freeze) picture →

Press STILL/PAUSE (To release, press PLAY)

■ To view in Slow Motion →

Press FF/SLOW+ (increases speed) or REW/SLOW- (decreases speed) in the Still mode (To release, press PLAY)

■ To view Frame by Frame Advance →

Press STILL/PAUSE in the Still mode (To release, press PLAY)

Notes

- After the unit is in Still or Slow mode for 3 minutes, it will switch to Stop mode automatically to protect the tape and the video head.

<For Model PV-DF2700 only>

- While main picture is TV mode, and VCR Playback in PIP mode, FF, REW, PLAY, STOP, SEARCH, CM SKIP and STILL operation is possible. During DVD playback on Main Picture, VCR cannot be operated with remote control buttons. Please use unit buttons.
- Pressing PLAY in Stop mode starts playback on the main screen only, not the PIP screen.

■ To stop → Press STOP

■ To rewind tape → Press FF/SLOW+ in Stop mode

■ To fast forward tape → Press REW/SLOW- in Stop mode

■ To eject tape → Press EJECT on the remote or STOP/EJECT on the unit

Features for a Quality Picture

Digital Auto Tracking

Continuously analyzes the signal and adjusts for optimum picture quality.

Manual Tracking Control (PIP screen is not displayed)

Use during Playback and Slow Motion mode to reduce picture noise.

Press the 3 or 6 NUMBERED key on the remote control or CH (TRACKING) ▲▼ on the unit until the picture clears up. To return to Auto Tracking, press POWER off, then on again a few seconds later.

V-Lock Control (PIP screen is not displayed)

In Still mode, the 3 or 6 NUMBERED key on the remote control or CH (TRACKING) ▲▼ on the unit operate as a V-Lock control to reduce jitter.

PureFlat™ Picture Tube

This unit is equipped with PureFlat™ Picture Tube.

You can operate on the unit

2 Press PLAY/REPEAT.

1 Insert a cassette.

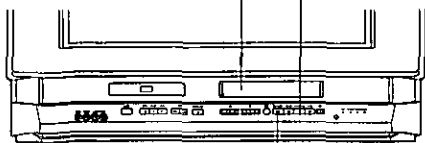

- Press to stop and/or eject tape.

Record On a Tape

Check list before you begin.

- All connections are made. (See page 9.)
- Your unit is plugged in.
- Cassette with record tab in place.

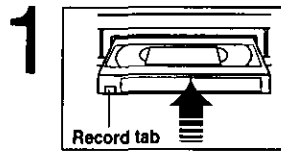
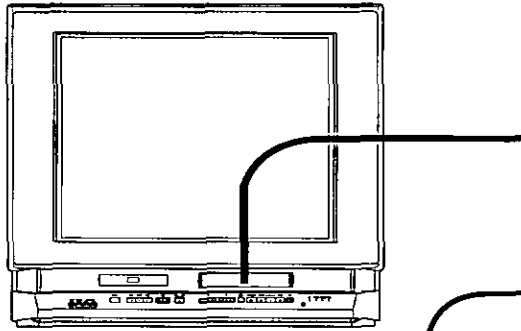

Insert a cassette.

- The unit power comes on automatically.

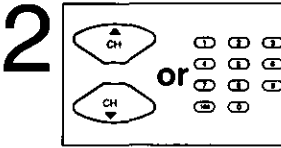

Select Channel.

- Press CH ▲▼*, or NUMBERED keys.
- To select "LINE1", "LINE2," see bottom of this page.



Select Recording speed (see page 6).

- Press SPEED.
- SP = Standard Play
 - LP = Long Play
 - SLP = Super Long Play
 - Selected speed is displayed.



Start Recording.

Press REC.

- To edit out unwanted portions, press STILL/PAUSE to pause and resume recording.
- You can not view another channel during recording. (For Model PV-DF2000 only)

<For Model PV-DF2700 only> (See page 30)

- You can view another channel during recording.
- Recording can only be started with the Main Picture.

■ **To stop** → Press STOP

■ **One Touch Recording (OTR)**

Press REC repeatedly to set the recording length (30 min - 4 hours.)

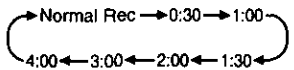

- The unit stops recording at the preset time.
- PROG TIMER indicator lights on the unit.

Notes

• It is not possible to record from DVD/ Video CD/CD to VHS tape using this unit.

- After the unit has been in Rec Pause mode for 5 minutes, it will stop automatically to protect the tape and video head.
- The remaining recording time of an OTR can be displayed by pressing DISPLAY.

<For Model PV-DF2700 only>

- If you select a channel and "RECORDING PLEASE TURN OFF PIP" appears, turn PIP off and try again.
- If PAUSE is pressed in PIP mode, "REC CH- PLEASE SWITCH TO RECORDING CH" is displayed. In this case, select recording channel and try again.

You can operate on the unit

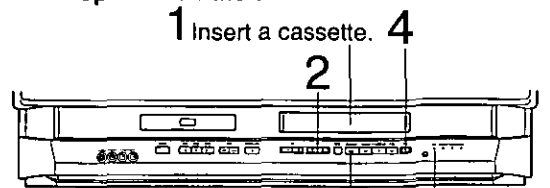

■ Press to stop. REC Indicator

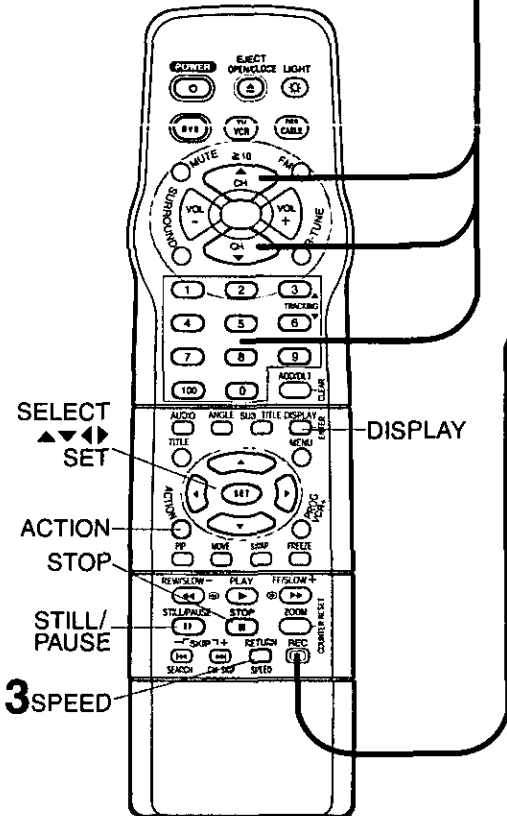

Model PV-DF2700 remote is shown here.

Selecting Input Mode

Method 1:

Press CH ▲▼. The display will change as follows.

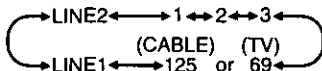

Method 2:

- a Press ACTION for MAIN MENU.
- b Press ▲▼◀▶ to select "TV", then press ACTION for SET UP TV screen.
- c Press ▲▼ to select "INPUT SELECT," and then press SET to select "TUNER", "LINE1" or "LINE2."
- d Press ACTION twice to exit this mode.

- LINE 1: For rear audio/video connection.
- LINE 2: For front audio/video connection.

Copy Your Tapes (Dubbing)

*Important: if a remote control button does not work when pressed, press the $\frac{VCR}{V}$ button on the remote and try the button again.

Connections you'll need to make.

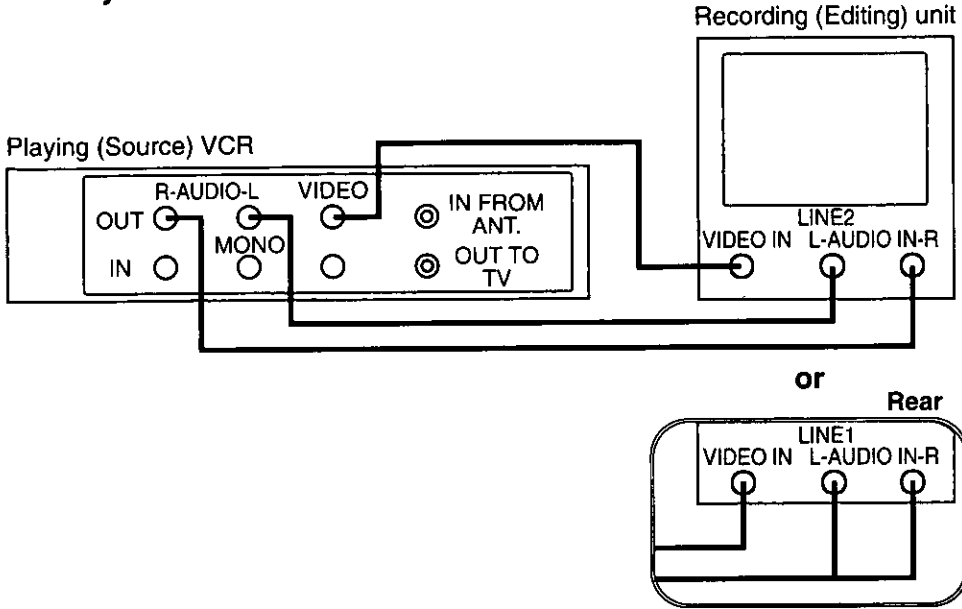

Basic Operation

Playback (Source) VCR

Recording (Editing) unit

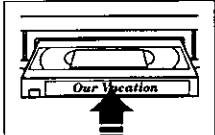
1  **Insert pre-recorded tape.**

 **Insert blank tape with record tab.**
 • Dubbing tapes protected with Copy Guard will have poor quality results.

2 _____ **Select "LINE" mode.**
 See "Selecting Input Mode" section on page 18.

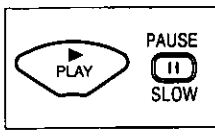
3  **Put in Standby mode.**
 Press PLAY, then PAUSE at starting point.

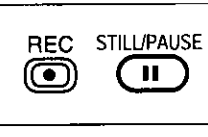
 **Put in Standby mode.**
 Press REC, then STILL/PAUSE immediately.

4  **Start dubbing.**
 Press PLAY.

 **Start dubbing.**
 Press STILL/PAUSE.

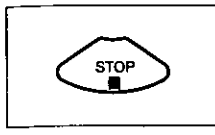
5  **Stop dubbing.**
 Press STOP/EJECT.

 **Stop dubbing.**
 Press STOP.

Notes

- Unauthorized exchanging and/or copying of copyrighted recordings may be copyright infringement.
- Please note that some discs cannot be dubbed on this unit.
- Also, it is not possible to dub DVD/Video CD/CD to VHS tape using this unit.

Basic DVD Operation

- Check list before you begin.**
- All connections are made. (See page 9.)
 - Your unit is plugged in.
 - Switch on the stereo system's power if the unit has been connected to an audio Amplifier.

1  **Press POWER* on the remote or unit.**

2  **Select DVD mode.**
Press DVD.
• If a disc is already inserted, go to step 4. (Depending on the disc, playback may start automatically.)

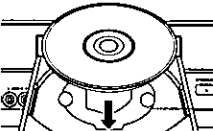
3  **Insert a disc.**
1) Press OPEN/CLOSE.
2) Place disc into disc tray.

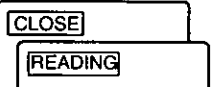
• Hold disc by its edges only (page 7) with printed side up and use guides to place into tray. Use **1** 3" (8 cm) or **2** 5" (12 cm) disc.

4  **Start play.**
Press PLAY.
The disc tray closes automatically.

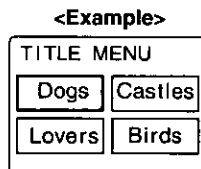
• Or, close the tray by pressing OPEN/CLOSE.
• Reading time differs depending on discs.

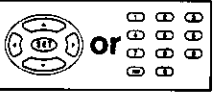
If an interactive DVD*¹ or a Video CD with playback control*² is used and a TITLE MENU appears, go to step 5.

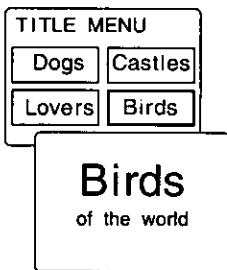

5  **Select the desired item.**
1) Press **▲▼◀▶** or NUMBERED key(s) as shown below.



1 digit number 1 ... 1
2 digit number 12 ... ≥10→1→2
3 digit number 123 ... 100→1→2→3

Press SKIP▶▶| or |◀◀ to go to next or previous menu screen.
• SKIP function not available with all discs. Please refer to disc jacket for operation information.

To return to menu (play stops)
Press TITLE, MENU, or RETURN. (DVD)
Press RETURN. (Video CD)

6  **Stop play.**
Press STOP.

7  **Eject the disc.**
Press OPEN/CLOSE.

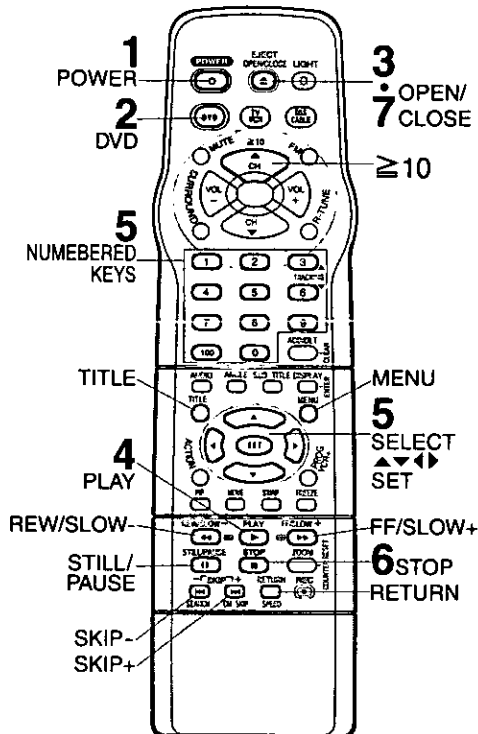

Model PV-DF2700 remote is shown here.

You can operate on the unit

4 Press PLAY.

3 Insert a disc. 3 Press OPEN/CLOSE.

7

1 Press POWER 6 Press to stop.

*¹ Interactive DVD...
May include multiple camera angles, stories, etc.

*² Video CD with playback control...
Particular scenes or information can be interactively selected from a menu that appears on the screen.

• Important: if a remote control button does not work when pressed, press the DVD button on the remote and try the button again.

■ To Find a Particular Scene

Rapid Advance →

Press FF/SLOW+ in play mode

Rapid Reverse →

Press REW/SLOW- in play mode

(To release, press PLAY)

- Starting rapid advance (reverse) during play started from menu on Video CDs may recall menu.
- The speed of advance (reverse), slow at first, increases with each additional press of the button up to 5 levels.

■ To Skip a Chapter/Track

Skipping Ahead →

Press SKIP ►►► during play

Each press skips a chapter (DVD) or track (Video CD/CD).

Skipping Back →

Press ◀◀◀ SKIP during play

Pressing once midway through a chapter/track returns to start of that chapter/track. Each additional press skips back one chapter/track.

- Pressing SKIP ►►► or ◀◀◀ during play started from menu on Video CDs may recall menu.

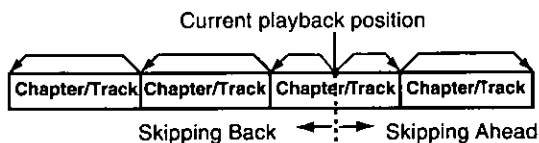

■ To view Still Picture (Pause)

Press STILL/PAUSE during play

(To release, press PLAY)

- DVD/Video CD : The unit will enter still picture mode.
- CD : The unit will enter pause mode.

■ To view Frame by Frame Advance (DVD/Video CD)

Each button press advances picture one frame.

Press STILL/PAUSE in still mode

(To resume normal play, press PLAY)

- Hold button down for consecutive frame advance.
- Whether pictures are advanced by "frame" or "field" is selected automatically.

■ To view Slow Motion (DVD/Video CD)

Press FF/SLOW+ or REW/SLOW- in still mode

(To release, press PLAY)

- Slow motion speed, slow at first, is increased with each additional press of the button up to 5 levels.
- For Video CDs, reverse slow motion is not available.

- When Ⓞ appears on the screen while a button is being operated, it means that the corresponding operation is prohibited by the unit or the disc.

RESUME function

The unit memorizes the point where STOP is pressed (▶ flashes on screen).

Press PLAY to resume play from this point.

Pressing STOP again or opening the tray cancels RESUME, however, RESUME is not canceled when power is turned off and on.

- RESUME works only with discs for which elapsed play time is displayed during play.

Auto-Power Off function

Power turns off after unit has been in stop mode (DVD) for about 5 minutes.

Enjoy Video CDs with playback control without using menus (Video CDs only)

1. Do steps 1-4 (previous page).
When menu appears, press STOP.
2. Press NUMBERED key(s) to select desired track (play begins).
 - Check disc for track numbers.
 - Press "1" to start at beginning of disc.

To resume menu use

Press RETURN, and then MENU. Now, go to step 5 (previous page).

Notes

- Please read the disc jacket for operation information.
- If a single sided disc is placed in upside down, "PLEASE CHECK THE DISC, AND FOR STAINS OR SCRATCHES ON DISC" is displayed.
- When Power is turned off while in DVD mode, the unit will be in TV mode the next time Power is turned on.
- Remove disc and press unit POWER off when not in use.
- Disc continues to rotate with menu displayed even after play is done. Press STOP to clear menu display when finished with menu.

<For Model PV-DF2700 only>

- TITLE MENU cannot be operated if displayed on the PIP. Press SWAP to switch it to Main Picture, then operate.
- During DVD playback on PIP, DVD cannot be operated by remote control. Press SWAP to switch to Main Picture, or use unit buttons.
- If PIP is canceled during DVD playback on PIP, DVD playback will stop after a while.
- Pressing PLAY in Stop mode starts playback on the main screen only, not the PIP screen.

Timer Recording

You can set up to 8 programs to be recorded while you are away.

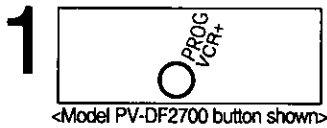

Display SET PROGRAM screen.

Press PROG/VCR+.

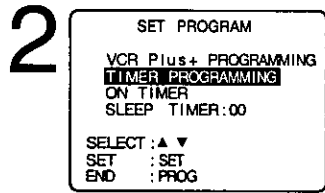

Select TIMER PROGRAMMING.

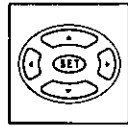

- 1) Press ▲▼ to select.
- 2) Press SET to display.

• If a program is already in memory, press ▲▼, and SET to select an unused program number.

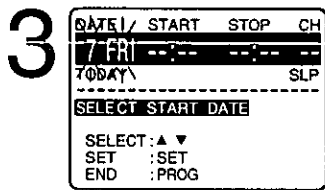

Set the recording DATE.

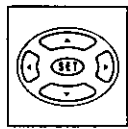

- 1) Press ▲▼ to select.
- 2) Press SET or ◀▶ to set.

- 1~31 = One time
- DAILY = MON~FRI
- WEEKLY SUN~SAT = Same time once a week

Example

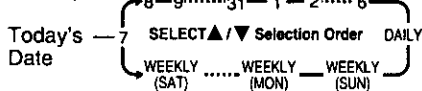

Repeat step 3 to set:

- start time, stop time
- Channel (or LINE for outside source)
- Speed (SP, LP, SLP)

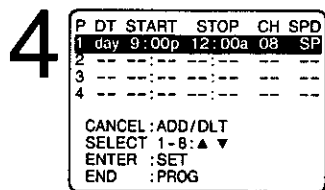

End the program.

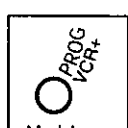

Press PROG/VCR+.

<Model PV-DF2700 button shown>

To Enter More Programs

Press ▲▼ and SET to select and set a blank program number, and then repeat steps 3 and 4.

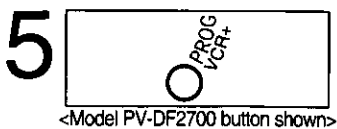

Exit this mode.

Press PROG/VCR+ twice.

- If you're using a cable box, make sure that it is tuned to the desired channel and the power is left on for timer recording.
- PROG TIMER indicator lights on the unit.

✓ Check list before you begin.

- All connections are made. (See page 9.)
- Your unit is plugged in.
- The clock is set to correct time.
- The tape is long enough.
- The record tab is in place.

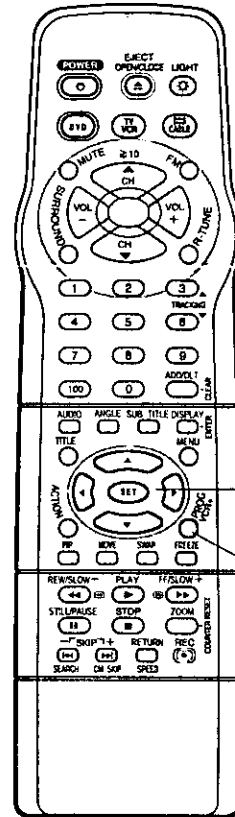

Model PV-DF2700 remote is shown here.

Notes

- If the start times of two programs overlap, the lower numbered program will have priority.
- If the start time for a Timer Recording comes up during a normal recording or One Touch Recording (page 18), the Timer Recording will not be performed.
- If "INCOMPLETE" appears after all items have been set, check all entries and make necessary corrections.
- If there is a power interruption of more than one minute, the recording may not be performed or continued.
- 2 minutes before Timer recording is performed, "PLEASE PREPARE FOR TIMER REC" appears and/or the PROG TIMER indicator flashes. Be sure a cassette with record tab is loaded and the unit is in Stop mode.

• Important: if a remote control button does not work when pressed, press the $\sqrt{\times}$ button on the remote and try the button again.

Review, Replace or Clear Program Contents : (Recording is not in progress)

a Repeat steps 1 and 2 on page 22.

b

P	DT	START	STOP	CH	SPD
1	day	9:00p	12:00a	08	SP
2	8	10:00a	12:00p	125	SP
3	10	8:00p	9:00p	10	SP
4	SU	9:00p	10:00p	L1	LP

CANCEL : ADD/DLT
SELECT 1-8: \blacktriangle \blacktriangledown
ENTER : SET
END : PROG

Select the desired program.

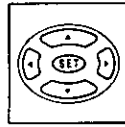

Press \blacktriangle \blacktriangledown to select.

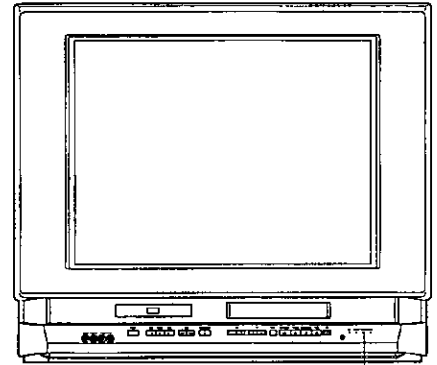

PROG TIMER indicator

c To Replace program...

DATE	START	STOP	CH
8 SAT	9:00P	12:00A	08

7 DAY SLP
SELECT START DATE

SELECT: \blacktriangle \blacktriangledown
SET : SET BACK: \blacktriangleleft
END : PROG

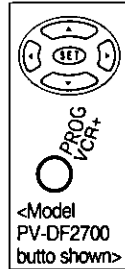

- 1) Press SET to display.
- 2) Press \blacktriangle \blacktriangledown to select and \blacktriangleleft \blacktriangleright or SET to set new program contents.
- 3) Press PROG/VCR+.

To Clear program...

P	DT	START	STOP	CH	SPD
1	---	---	---	---	---
2	8	10:00p	12:00a	125	SP
3	10	8:00p	9:00p	10	SP
4	SU	9:00p	10:00p	L1	LP

SELECT 1-8: \blacktriangle \blacktriangledown
ENTER : SET
END : PROG

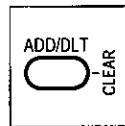

Press ADD/DLT.

d

<Model PV-DF2700 button shown>

Exit this mode.
Press PROG/VCR+ twice.

Cancel a Timer Recording: (Recording is in progress)

Hold down STOP for a few seconds to cancel the Timer Recording.

- Any future daily or weekly recordings will be performed as programmed.

Note <For Model PV-DF2700 only>

- If a timer recording starts in PIP mode, the current PIP will be replaced with the timer recording picture. However, if the PIP source is LINE input or if you are watching a DVD/Video CD/CD, the picture will not change.

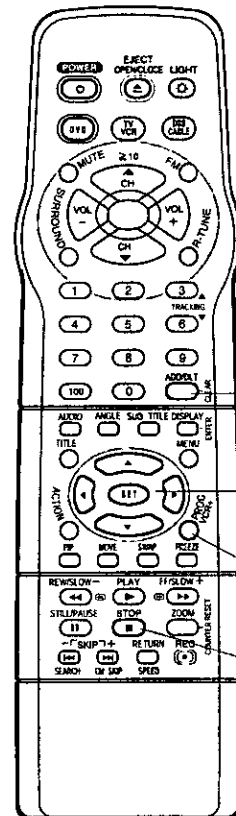

Model PV-DF2700 remote is shown here.

Timer Programming using VCR Plus+® System

VCR Plus+ System is...

a feature that allows you to set most items of a Timer Recording by simply entering a special code number (PlusCode) found in TV GUIDE and selected newspaper TV listings.

Process of Recording

Connection → **Setup** → **Programming**

Choose your connection type from the following diagrams

■ CABLE BOX → UNIT

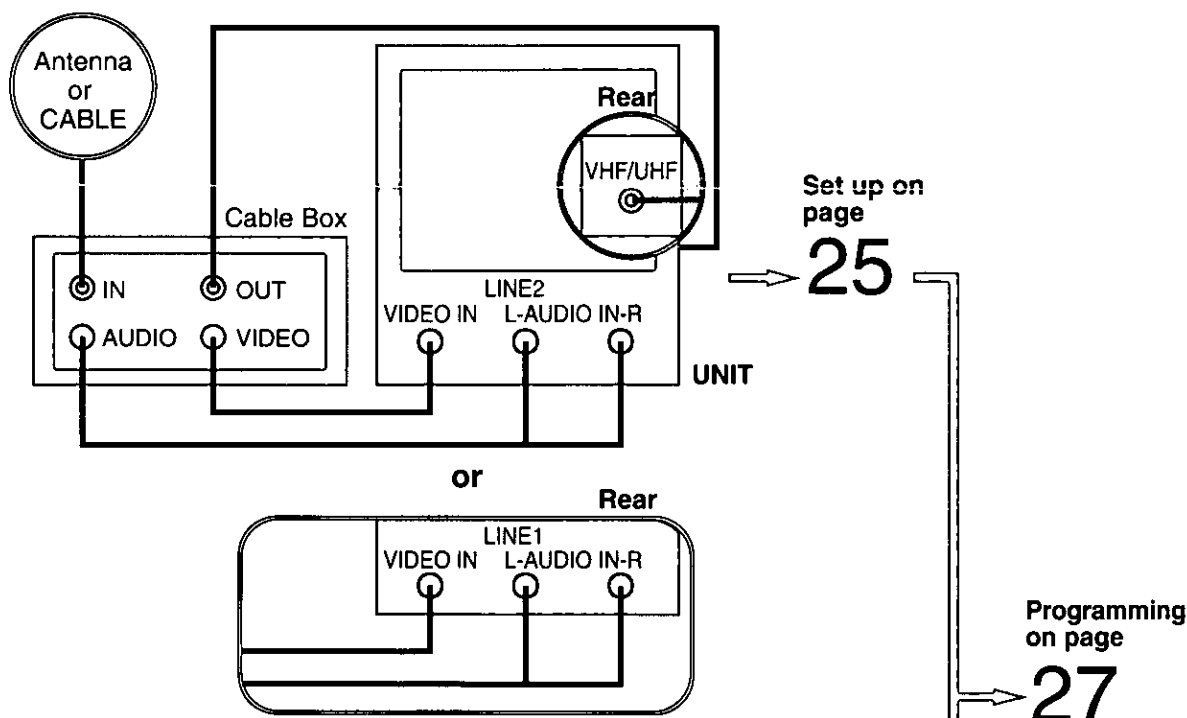

■ ANTENNA or CABLE → UNIT

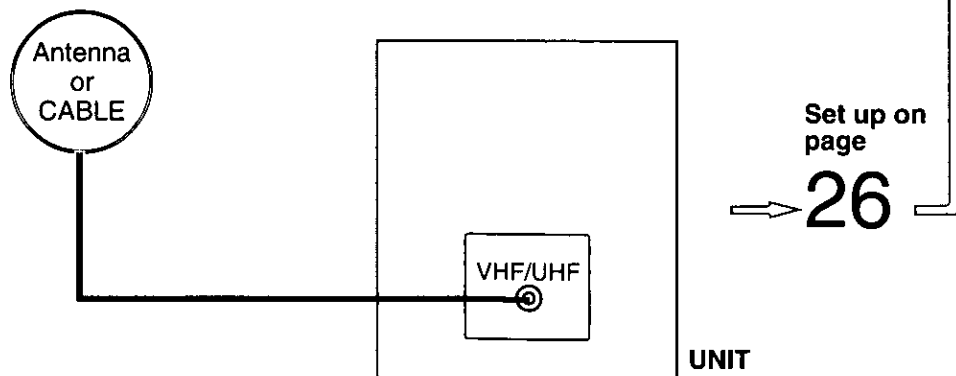

*Important: if a remote control button does not work when pressed, press the $\sqrt{\text{TV}}$ button on the remote and try the button again.

Cable Box Setup

Process of Recording

Connection → Setup → Programming

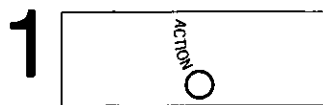

<Model PV-DF2700 button shown>

1 Display MAIN MENU.

Press ACTION*.

Check list before you begin.

It is necessary to enter TV mode by pressing $\sqrt{\text{TV}}$ before selecting "CH" on the MAIN MENU.

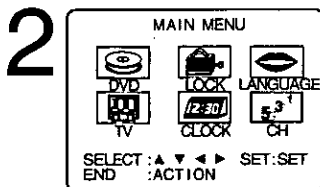

2 Display SET UP CHANNEL screen.

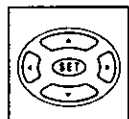

- 1) Press ▲▼◀▶ to select "CH."
- 2) Press SET to display.

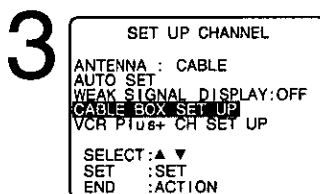

3 Select CABLE BOX SET UP.



- 1) Press ▲▼ to select.
- 2) Press SET to display.

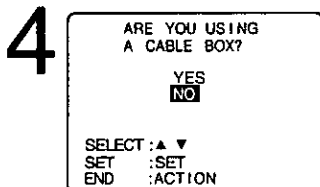

4 Select "YES" or "NO."

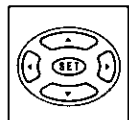

- 1) Press ▲▼ to select "YES" or "NO."
- 2) Press SET to set.

If you select...

■ "YES" → Step 5.

■ "NO" → Press ACTION → Go to VCR Plus+ Channel Setup on page 26.

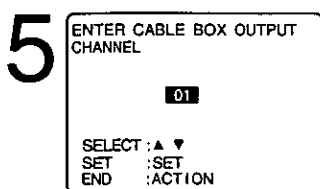

5 Select Cable Box output channel number.

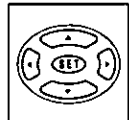

- 1) Press ▲▼ to select.
- 2) Press SET to enter.

- If necessary, refer to your cable box manual.
- If you are using Audio/Video jack connection for your cable box, select and set "VIDEO OUT" as the output channel.

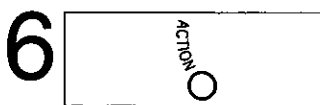

<Model PV-DF2700 button shown>

6 Redisplay SET UP CHANNEL screen to continue setup.

Press ACTION and go to page 26 (VCR Plus+ Channel Setup)

OR

to exit, press ACTION three times.

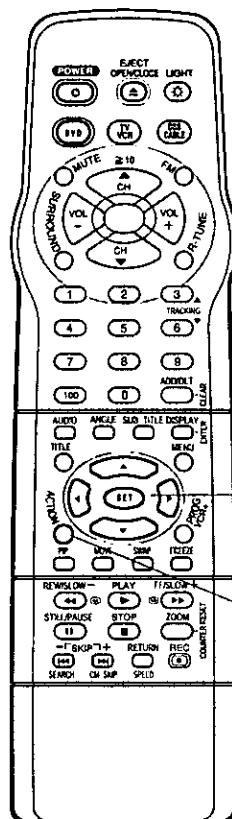

Model PV-DF2700 remote is shown here.

VCR Plus+ and PlusCode are registered trademarks of Gemstar Development Corporation. The VCR Plus+ system is manufactured under license from Gemstar Development Corporation.

Timer Programming using VCR Plus+® System (continued)

VCR Plus+ Channel Setup Is...
 necessary to program the unit with local
 channel information for proper VCR Plus+
 operation.

Process of Recording



Check list before you begin.

It is necessary to enter TV mode by pressing **TV** before selecting "CH" on the MAIN MENU.

VCR Plus+ Channel Setup

At first, do Channel Setup Preparations below right.

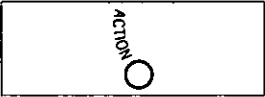
1  **Display MAIN MENU.**
 Press ACTION*.

<Model PV-DF2700 button shown>

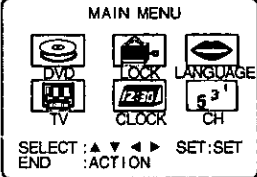
2  **Display SET UP CHANNEL screen.**
 Press SET.

1) Press **▲▼◀▶** to select "CH."
 2) Press **SET** to display.

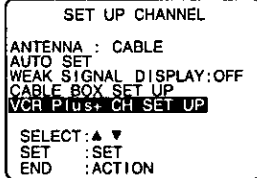
3  **Select VCR Plus+ CH SET UP.**
 Press SET.

1) Press **▲▼** to select.
 2) Press **SET** to display.

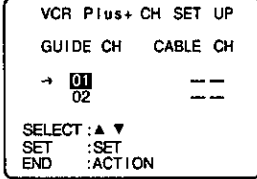
4  **Enter VCR Plus+ channels.**
 Press SET.

1) Press **▲▼** to scroll up/down the GUIDE CH column.
 2) Press **SET** to move cursor to right column.
 3) Press **▲▼** to change the CABLE CH number.
 4) Press **SET** to set.

To Make Corrections
 Press **▲▼** and **SET** to move to error, then **▲▼** to change, or **ADD/DLT** to erase number.

• Repeat step 4 until list is complete.

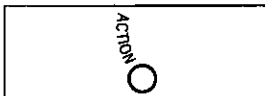
5  **End the setup.**
 Press ACTION three times.

<Model PV-DF2700 button shown>

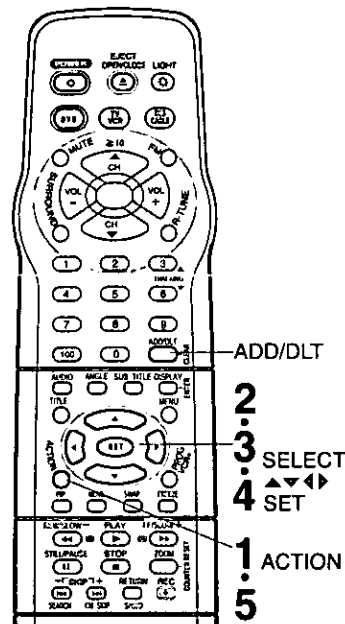

Model PV-DF2700 remote is shown here.

Channel Setup Preparations

To complete step 4 left, make a local channel list (see example below.)

You will need the following:

- A normal TV and/or Cable stations line up and the channel numbers you receive them on.
- A list of Guide (VCR Plus+) channel numbers for stations you receive (see TV Guide and selected newspapers.)

- 1 Make a 3-column chart. In the left column, write all station names you receive.
- 2 In the middle column, write each station's Guide (VCR Plus+) number.
- 3 In the right column, write the channel number your TV receives the station on.

< EXAMPLE ONLY >

Broadcast or Cable Station Name	Assigned Guide (VCR Plus+) Channel no.	Channel no. your TV receives the station on
HBO	33	15
Nickelodeon	38	20
CBS	34	04
FOX	11	

Notes

- Make each entry within 5 minutes or the unit will leave this mode.
- Once local channels have been programmed, they will stay in memory, even in the case of a power failure.

*Important: if a remote control button does not work when pressed, press the $\frac{TV}{VCR}$ button on the remote and try the button again.

VCR Plus+ System Programming

Process of Recording

Connection \leftrightarrow Setup \leftrightarrow Programming

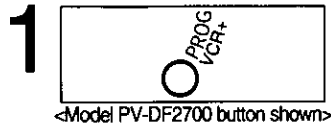

Display SET PROGRAM screen.

Press PROG/VCR+.

- Check list before you begin.**
- The clock is set to correct time.
 - VCR Plus+ System Setup is complete. (See pages 25, 26.)

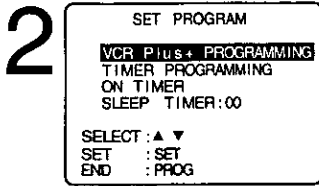

Select VCR Plus+ PROGRAMMING.

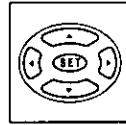

- 1) Press $\blacktriangle/\blacktriangledown$ to select.
- 2) Press SET to display.

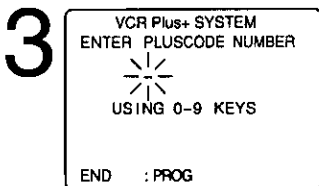

Enter PlusCode programming number.

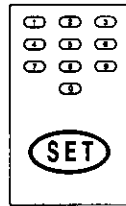

- 1) Press NUMBERED keys.
- 2) Press SET when finished.

To Make Corrections
Press \blacktriangleleft repeatedly to delete the PlusCode programming number.

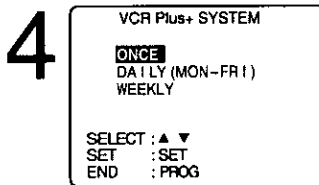

Set Record Frequency.

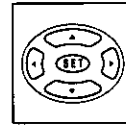

- 1) Press $\blacktriangle/\blacktriangledown$ to select.
- 2) Press SET to set.

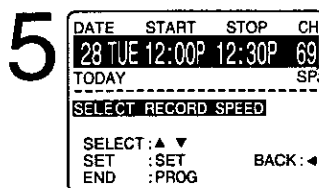

Set Recording speed.
(See page 6.)

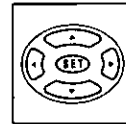

- 1) Press $\blacktriangle/\blacktriangledown$ to select.
- 2) Press SET to set.

Select desired type
• Speed \Rightarrow SP, LP, or SLP
To Make Corrections
Press $\blacktriangleleft/\blacktriangleright$ to move the cursor and $\blacktriangle/\blacktriangledown$ to make the correction.

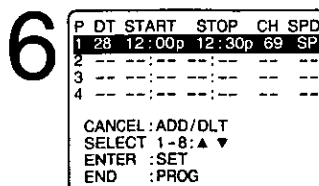

End programming.

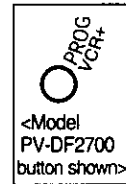

Press PROG/VCR+.

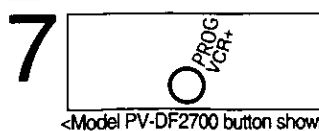

Exit this mode.

Press PROG/VCR+ twice.

- PROG TIMER indicator lights on the unit.

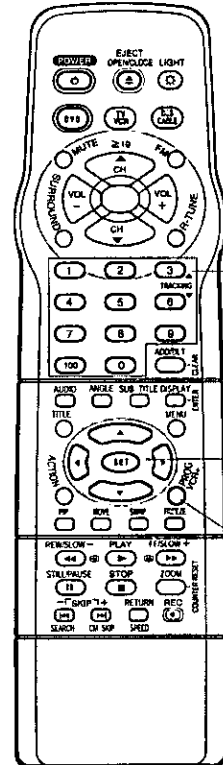

Model PV-DF2700 remote is shown here.

Use normal Timer Recording steps if:

- a program PlusCode programming number is not listed.
- the program, such as a sporting event, may run over the scheduled stop time.

See page 23 to:

- cancel a timer recording in progress.
- replace program contents.
- review or clear program contents once set.

Notes

- If you're using a cable box, make sure that it is turned to the desired channel and the power is left on for timer recording.
- You can obtain unlisted PlusCode programming numbers by calling 1-900-454-7587. Call costs approximately \$.95 per minute.
- Avoid overlapping program times.
- Timer program memory capacity is 8. To add programs when memory is full, please first clear other programs. (See page 23.)

Cable Box Universal Remote Control Feature

Universal Remote Control Setup

1 Find your DSS box or Cable box Brand Code Number from one of the charts on the next page.

2

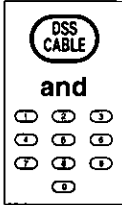

Setup remote.

- 1) Hold down DSS CABLE.
- 2) Press NUMBERED keys to enter code.

- Enter numbers as follows:
e.g. For 02, enter 0, then 2.
For 25, enter 2, then 5.
For 102, enter 1, then 0, then 2.

3

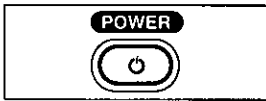

Confirm code entry.

Press POWER* to turn selected unit ON or OFF.

- See below for a list of controllable functions in each mode.

Notes

- The remote control will not operate all DSS receivers or Cable Boxes made by the manufacturers listed. If you get no results, your particular brand cannot be controlled.
- Please repeat the Universal Remote Control Setup after replacing remote control batteries.

Using the Universal Remote Control (Available Buttons / Functions)

Once the remote control has been properly set up, you can select TV-VCR, FM, DVD, DSS or CABLE mode depending on which functions you wish to control. (See below.)

Press ^{TV}VCR, FM, DVD, or DSS CABLE on the remote control to select the desired mode. (See below for buttons available in each mode.)

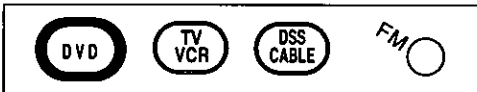

Set to ^{TV}VCR, FM, DVD:

All TV functions, as well as functions of TV-VCR, FM, or DVD.

Set to DSS CABLE:

- Basic VCR functions, e.g. PLAY, REC, etc.
- CABLE/DSS functions, e.g. POWER, ENTER, NUMBERED keys (except 100 key), CH UP/DOWN.

Notes

- In DSS or CABLE mode, POWER, CH Up/Down, NUMBERED keys, ACTION, PROG/VCR+, DISPLAY/ENTER, SEARCH/SKIP-, R-TUNE, SELECT, SET, CM SKIP/SKIP+, COUNTER RESET/ZOOM, ANGLE, AUDIO, TITLE, SUBTITLE, MENU, or ADD/DEL/CLEAR are not available. Press ^{TV}VCR, FM, DVD to use these functions.
- Due to changes in infra-red commands used by manufacturers, some brands have several codes. If your unit does not respond to the first code, please try the next one.
- In DSS or CABLE mode, it may be necessary to press ENTER after pressing NUMBERED keys for channel selection.
- Depending on your DSS receiver or Cable box brand, some of the functions listed may not be remote controllable.
- Some DSS receiver or Cable box brands require you to turn on the power manually.

Universal Remote Control is...

The Remote Control may be set up to control some basic DSS or Cable box functions.

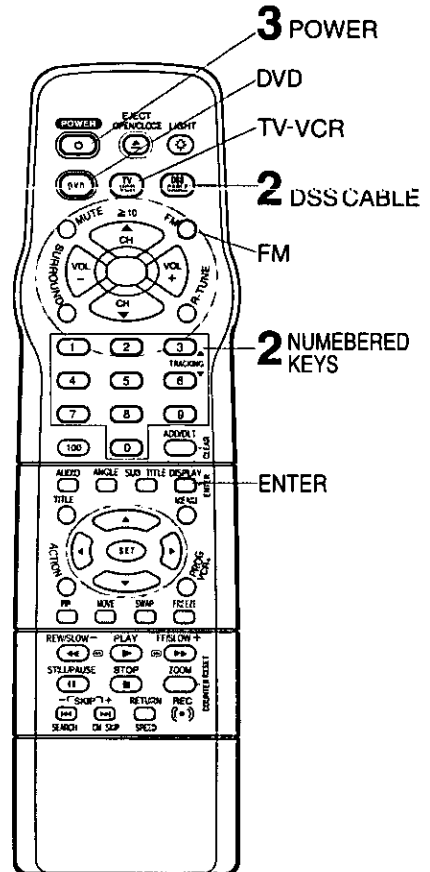

Model PV-DF2700 remote is shown here.

• Important: If a remote control button does not work when pressed, press the $\sqrt{\text{V}}$, DVD, FM button on the remote and try the button again.

Remote Warning ON/OFF

When Universal Remote Control (previous page) is used, and this feature is set to "ON," a warning appears whenever an invalid key is pressed in DSS or Cable mode.

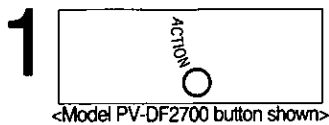

Display MAIN MENU.

Press ACTION.

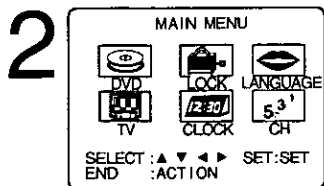

Display SET UP TV screen.

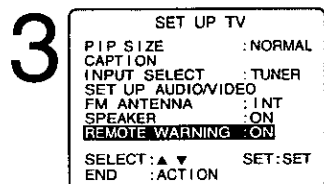
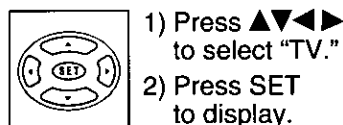

Select REMOTE WARNING.

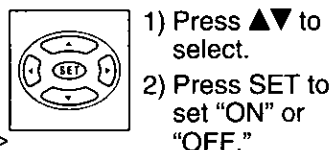

<Model PV-DF2700 screen shown>

• "OFF" → Remote warning will not appear even if invalid key is pressed.

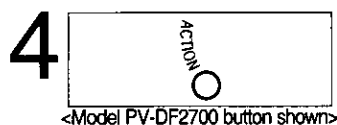

Return to normal screen.

Press ACTION twice.

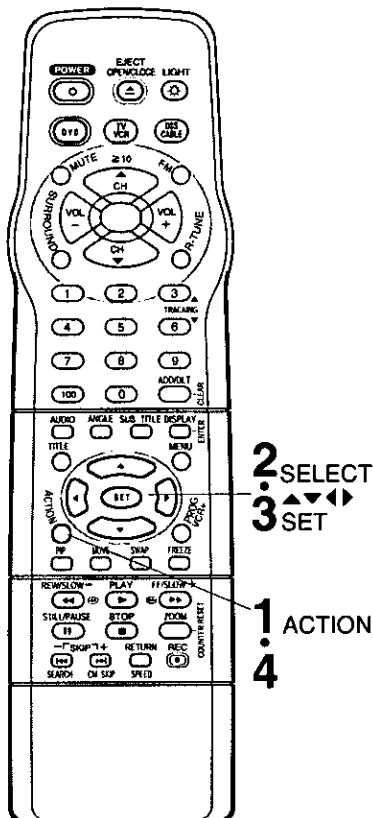

Model PV-DF2700 remote is shown here.

DSS Brand Code Numbers

Toshiba	90	Magnavox	94, 95	ProScan	97
Hitachi/ Hughes	91, 99	Uniden	94, 95	RCA	97
Primestar	92	Optimus	94, 95	SONY	98, 105
Drake	93	Panasonic	96		

Cable Box Brand Code Numbers

Archer	44, 06, 01, 120, 05, 63, 126	Jasco	30, 04, 124	Rembrandt	44, 42, 63, 29, 01, 32, 39, 120, 126
Cableview	29, 09, 01, 63, 120, 44, 42, 30, 52, 04, 124, 126	Macom	31	Samsung	42, 06, 32, 05, 40
Citizen	44, 52, 30, 63, 42, 04, 124, 126	Magnavox	26, 112	Scientific Atlanta	08, 09, 25, 61, 53, 87
Curtis	08, 09, 25, 61, 53, 87	Matsushita	17, 16, 08, 87, 109	Shertech	27
Century	44, 51, 75, 59, 126	Movietime	32, 39, 42, 44, 126, 38, 40	Signal	26, 112
Cabletenna	29, 09, 01, 63, 120, 44, 126	Maestro	74, 35	SL Max	42, 06, 32, 40, 43, 44, 52, 63, 126
Cable Cinema	29, 09, 01, 63, 120, 44, 126	NEC	40, 19, 38, 32	Sprucer	17, 16, 08, 87, 109
Diamond	29, 09, 01, 63, 120, 44, 126	NSC	40, 19, 38, 32	Standard Components	32, 39, 42, 44, 126
Eagle	62, 40, 22, 13, 58, 20, 26, 107	Novavision	08, 09, 25, 61, 53, 87	Stargate	04, 42, 32, 40, 63, 44, 30, 52, 06, 124, 126
Eastern	28, 29, 130	Next Level	01, 84, 83, 34, 03, 02, 04, 55, 65, 66, 67, 68, 120, 106, 121, 122	Sylvania	19, 18
Explorer	08, 09, 25, 61, 53, 87	Oak	46, 11, 129, 101	Teknika	74, 35
Gemini	30, 04, 124	Oak Sigma	46, 11, 129, 101	Telecaption	77, 127
General Electric	01, 57, 120	Panasonic	17, 16, 08, 87, 109	Television	40, 19, 38, 32, 42, 06
General Instruments	01, 84, 83, 34, 03, 02, 04, 55, 65, 66, 67, 68, 120, 106, 121, 122, 115, 117, 118, 124	Philips	23, 24, 20, 13, 07, 50, 128, 129	Texscan	19, 18
Gerrard	44, 51, 75, 59	Pioneer	06, 05, 12	Tocom	34, 33, 01, 42, 66, 120
GC Electronics	44, 42, 63, 29, 30, 52, 04, 124, 126	Pulsar	04, 42, 63, 44, 30, 52, 124, 126	Toshiba	36
Hamlin	41, 14, 15, 28, 102, 104, 103, 130	Quest	06, 05, 12	Unika	44, 42, 63, 29, 01, 126, 120
Hitachi	31	Radio Shack	44, 51, 75, 59, 126	Universal	52, 43, 44, 63, 42, 126
Jerrold	01, 84, 83, 34, 03, 02, 04, 55, 65, 66, 67, 68, 120, 106, 121, 122, 115, 117, 118, 124	RCA	17, 16, 08, 87, 109	Viewstar	62, 40, 22, 13, 58, 20, 26, 107
		Realistic	44, 51, 75, 59, 126	Videoway	07, 23, 50, 129
		Recoton	44, 51, 75, 59, 126	Vidtek	64
		Regal	41, 14, 15, 28, 102, 104, 103, 130	Zenith	07, 23, 50, 129
		Regency	28, 29, 130		

Picture in Picture (PIP) Operation

<For Model PV-DF2700 only>

You can view two pictures simultaneously using Picture in Picture (PIP) display function.

Display Picture in Picture (PIP) screen

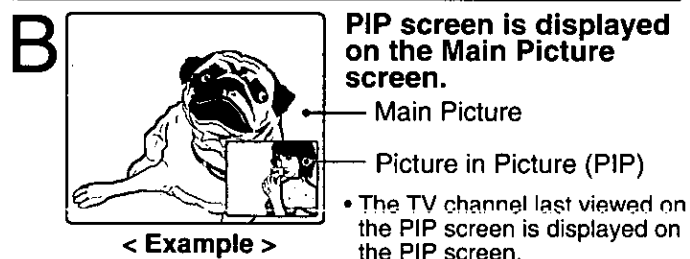

Select channel / Adjust Volume in PIP mode

In PIP mode, select a channel using CH ▲▼ or NUMBERED keys and adjust the volume using VOL + - for the Main Picture only. To select the PIP channel, first press SWAP to switch the PIP to the Main Picture, then select (see page 31.)

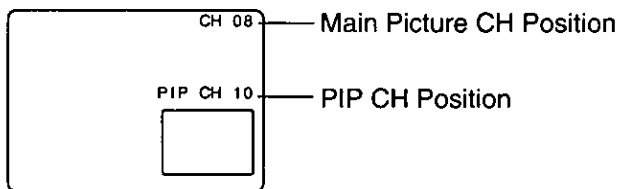

Move screen

You can move the PIP screen to four positions.

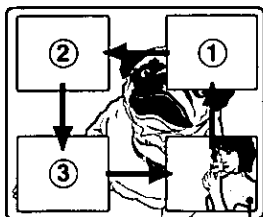
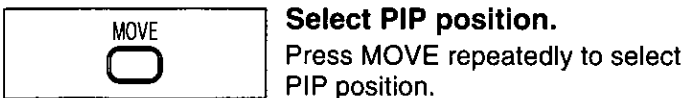

Initial Position

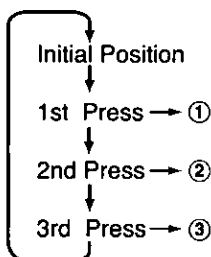

Possible Source Combinations for Main Picture and PIP Screen

The Main Picture source and the PIP Screen source can be displayed at the same time.

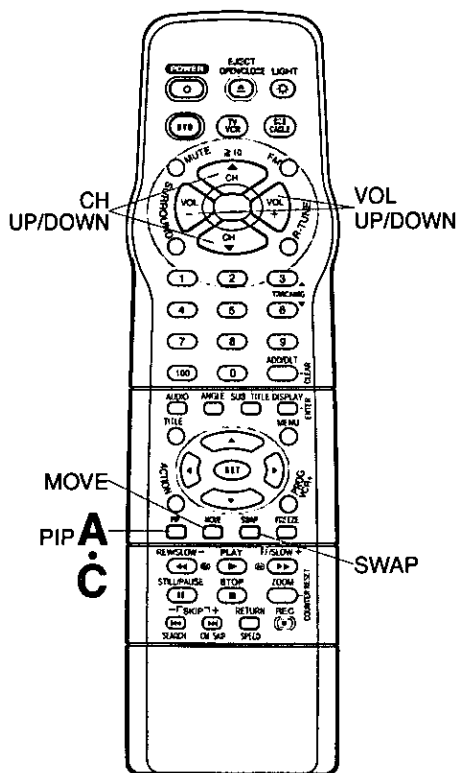
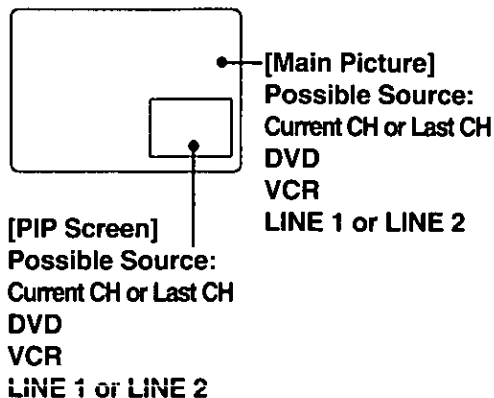

Model PV-DF2700 remote is shown here.

Notes

- The audio is from the Main picture only.
- PIP is not available in FM mode, while V-Chip control is active, while a LINE input has no signal, or while a blue-back (PROG, ACTION, MENU) screen is displayed.
- PIP position and size you set will be retained.
- The MOVE and SWAP buttons are inoperative when PIP screen is off.

•Important: if a remote control button does not work when pressed, press the TV/VCR/DVD button on the remote and try the button again.

<For Model PV-DF2700 only>

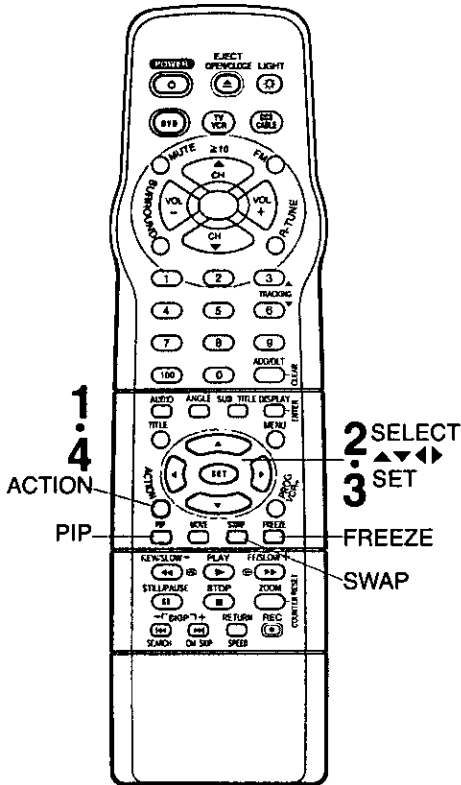

Model PV-DF2700 remote is shown here.

SWAP Picture

You can switch the PIP and Main Picture source.



Swap the Picture source.
Press SWAP.



FREEZE Picture into PIP

You can create a freeze frame PIP of the Main Picture.



Freeze the Main Picture as a PIP screen.
Press FREEZE.



Still Picture



Change PIP back to a moving picture.
Press FREEZE.

• With PIP displayed, each press of FREEZE will freeze and unfreeze the PIP.

To remove PIP, press the PIP button.

Picture in Picture (PIP) SIZE Setup

You can choose "NORMAL" or "SMALL" PIP size.

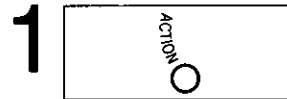

Display MAIN MENU.
Press ACTION*.

<Model PV-DF2700 button shown>

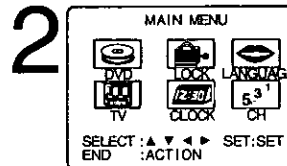

Display SET UP TV screen.

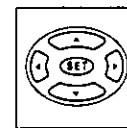

- 1) Press ▲▼▶◀ to select "TV."
- 2) Press SET to display.

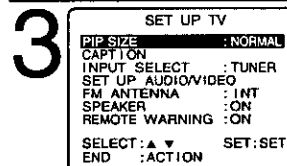

Select PIP SIZE .

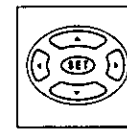

- 1) Press ▲▼ to select "PIP SIZE."
- 2) Press SET to set "NORMAL" or "SMALL."

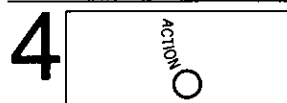

End setup.
Press ACTION twice.

<Model PV-DF2700 button shown>

Notes

- The FREEZE function works the same way during VCR or DVD playback.
- When DVD and VCR pictures are played back on Main Picture and PIP, pressing FREEZE only freezes the PIP screen while actual playback continues. Canceling freeze frame restores playback picture in progress.
- A freeze frame PIP reverts to a normal (moving) picture when the PIP and the Main Picture are swapped.

Closed Caption System

Closed Caption Mode Feature

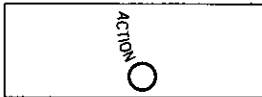
1  **Display MAIN MENU.**
Press ACTION*.

<Model PV-DF2700 button shown>

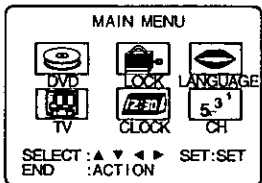
2  **Display SET UP TV screen.**

1) Press ▲▼◀▶ to select "TV."
2) Press SET to display.

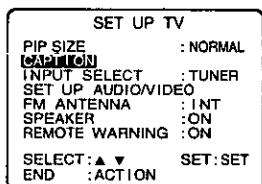
3  **Display CAPTION screen.**

1) Press ▲▼ to select.
2) Press SET to display.

<Model PV-DF2700 screen shown>

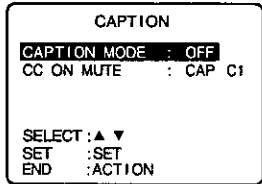
4  **Select CAPTION MODE.**

1) Press ▲▼ to select.
2) Press SET repeatedly to select caption mode.

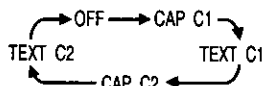

5  **Return to the normal screen.**
Press ACTION three times.

<Model PV-DF2700 button shown>

Closed Caption is ...
This multi-use system not only allows the hearing impaired to enjoy selected programs, but also makes useful information from TV stations available to everyone.

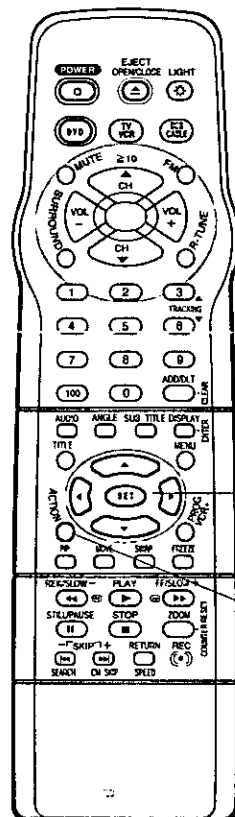

Model PV-DF2700 remote is shown here.

Recording and Playing Back a Closed Caption/Text Program

Record:
Record normally. Closed Caption/Text signal, if present, is recorded automatically.

Playback:
Start playback. Do above steps to select desired caption mode.

Closed Caption Modes you can Choose

Caption Mode: CAP C1 or C2
A narration of selected TV programs is displayed.
Check TV program listings for C. C. (Closed Caption) broadcasts.

Caption Mode: TEXT C1 or C2
The lower half of the screen will be blocked out. When the TV station broadcasts information, such as program listings, it will appear in this space.

Caption Mode: OFF
Closed Caption /Text narration will not be displayed.

NOTE:
The closed caption or text signal may be broadcast over C1, C2, or both. Also, text contents can vary so you may wish to try different settings.

*Important: if a remote control button does not work when pressed, press the $\sqrt{\text{TV}}$ button on the remote and try the button again.

Caption On Mute Feature

Closed Caption narration, if available, is displayed when MUTE button is pressed for silence.

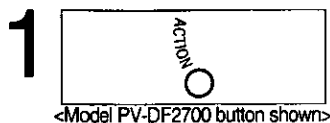

<Model PV-DF2700 button shown>

Display MAIN MENU.

Press ACTION.

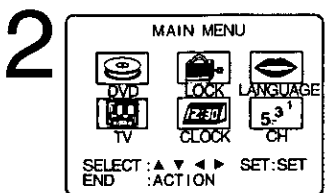

Display SET UP TV screen.

- 1) Press \blacktriangle \blacktriangledown \blacktriangleleft \blacktriangleright to select "TV."
- 2) Press SET to display.

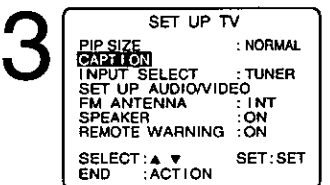
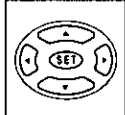

Display CAPTION screen.

- 1) Press \blacktriangle \blacktriangledown to select.
- 2) Press SET to display.

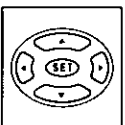

<Model PV-DF2700 screen shown>

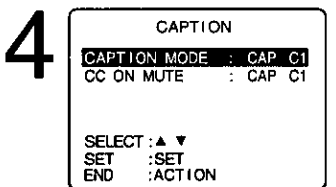

Set CAPTION MODE OFF.

- 1) Press \blacktriangle \blacktriangledown to select.
- 2) Press SET repeatedly to select "OFF."

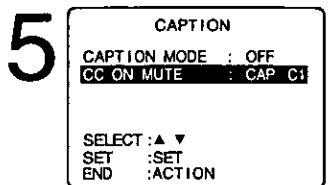
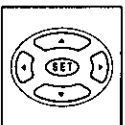

Select CC ON MUTE.

- 1) Press \blacktriangle \blacktriangledown to select.
- 2) Press SET repeatedly to select desired caption mode.

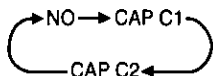
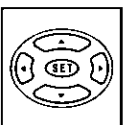

- Each press of SET will change the display as shown at left.
- The caption may be broadcast over CAP C1 or C2.

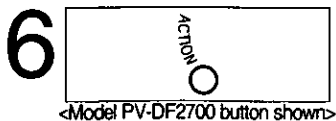

<Model PV-DF2700 button shown>

Return to the normal screen.

Press ACTION three times.

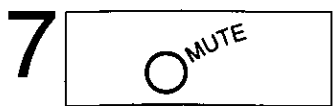

Mute sound, display closed captioning.

Press MUTE to mute the sound.

- To cancel, press MUTE again.

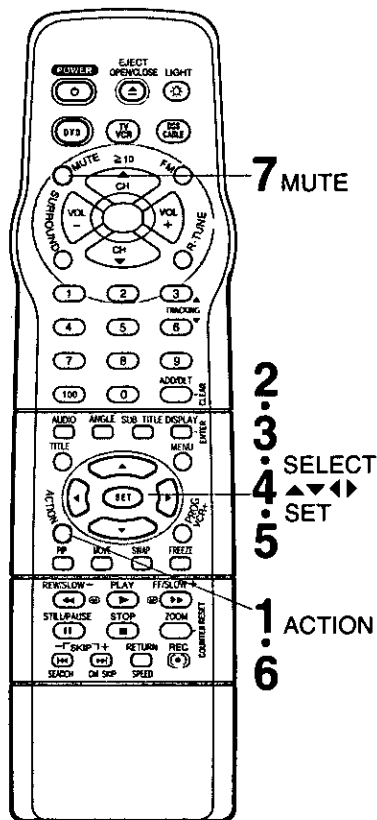

Model PV-DF2700 remote is shown here.

Notes

- When a disc supporting closed caption is used, the subtitle and the closed caption may overlap. In this case, turn the subtitle or caption on mute mode off. (See page 50.)

<For Model PV-DF2700 only>

- Closed Captioning can only be displayed on the Main Picture screen, and not the PIP.

FM Radio

FM Radio Setup

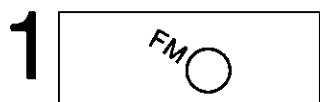

Display FM radio mode.

Press FM on the remote or TV/FM on the unit.

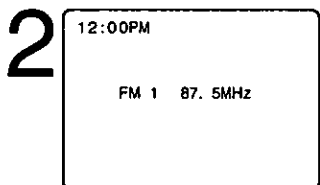

Select the FM number.

Press a **NUMBERED** key* (1~9.)

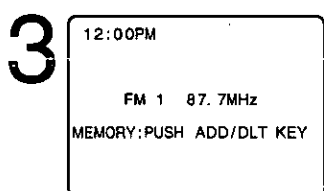
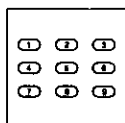

Set the radio station.

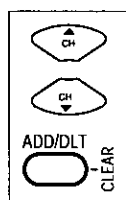

- 1) Press CH ▲▼ to select the desired radio station. (Each press changes frequency 200 kHz.)
- 2) Press ADD/ DLT to set.

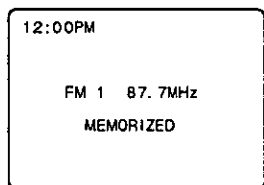

Quick Station Scan

Hold down CH ▲ or ▼ for a few seconds, then release to scan for FM stations in your area.

* To cancel, press CH ▲ or ▼ while in search mode.

To Make Corrections, select station with a NUMBERED key, then do step 3 again.

To exit FM mode, press TV on the remote or TV/FM on the unit.

FM Radio is ...

This unit has an FM radio with built-in antenna, 9 station preset, and a band range of 87.5 ~ 108.1 MHz. You can even set the On-Timer (page 36) to wake up to your favorite radio station.

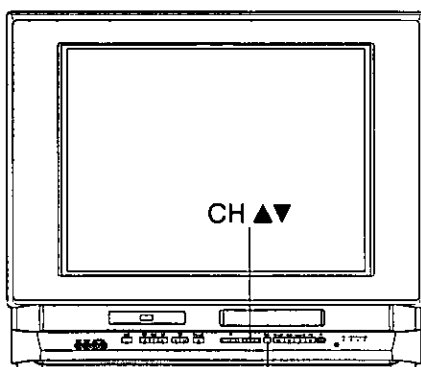

1 TV/FM

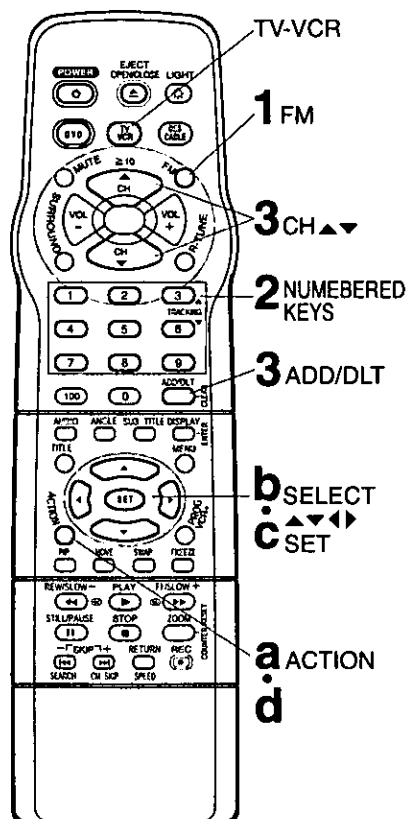

Model PV-DF2700 remote is shown here.

FM ANTENNA Setup

Make sure FM tuning is done correctly (See FM Radio Setup.)

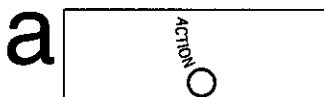

Display MAIN MENU.

Press ACTION.

<Model PV-DF2700 button shown>

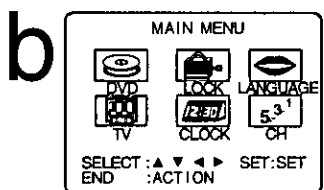

Display SET UP TV screen.

- 1) Press ▲▼◀▶ to select "TV."
- 2) Press SET to display.

Continued on the next page...

• Important: if a remote control button does not work when pressed, press the FM button on the remote and try the button again.

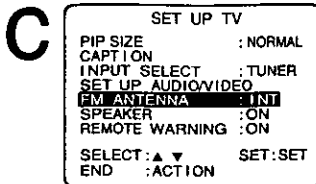

<Model PV-DF2700 screen shown>

- For cable TV users → "INT"
- For antenna users → "EXT"

Select FM ANTENNA.

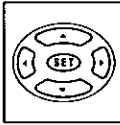

- 1) Press ▲▼ to select.
- 2) Press SET to select "INT (INTERNAL)" or "EXT (EXTERNAL)" whichever sounds the best.

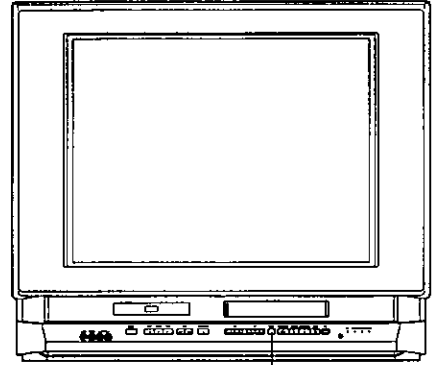

A TV/FM

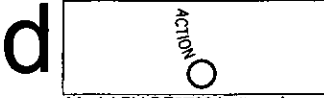

<Model PV-DF2700 button shown>

End setup.

Press ACTION twice to exit.

Using FM Radio



Display FM radio mode.

Press FM on the remote or TV/FM on the unit.

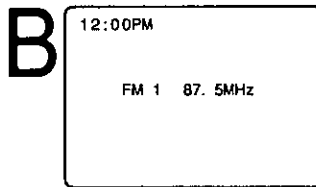

Select the FM number.

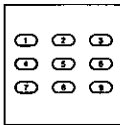

Press a NUMBERED key (1-9) to select a preset station (see steps 2 and 3 on the previous page.)

To cancel, press TV/VCR on the remote or TV/FM on the unit.

Notes

Once stations are set, the selected station and current time are displayed when FM Radio mode is entered. To remove time, press DISPLAY. If DISPLAY is pressed, the unit status screen appears.

Select Audio Mode for FM Radio

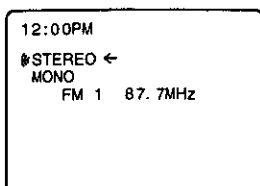

Select "STEREO" or "MONO."

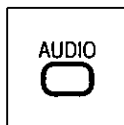

Press AUDIO repeatedly in FM Radio mode.

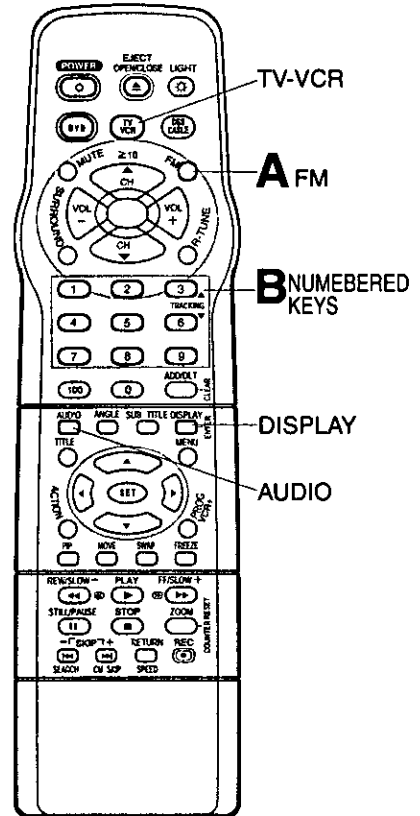

Model PV-DF2700 remote is shown here.

Notes

- FM radio cannot be recorded on a Video cassette.
- You cannot select FM Radio mode during playback or record, or while a blue back screen (PROG, ACTION, MENU) is displayed.
- You may get better reception by repositioning the unit.

<For Model PV-DF2700 only>

- PIP function cannot be used while in FM mode.

TV Timer Features

• Important: if a remote control button does not work when pressed, press the button on the remote and try the button again.

ON-TIMER with Alarm

This unit can be set to automatically power on in one of 4 modes (TV, VCR Playback, FM radio, or DVD/Video CD/CD.) You can also combine the On-Timer with a one minute alarm that gradually increases in volume.

1 Display SET PROGRAM screen.

Press PROG/VCR+*.

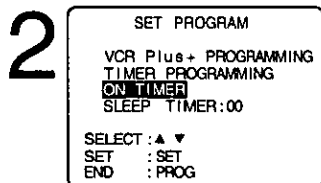

Select ON TIMER.

- 1) Press ▲▼ to select.
- 2) Press SET to display.

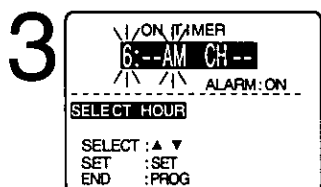

Set the ON-TIMER TIME.

- 1) Press ▲▼ to select.
- 2) Press SET to set.

• ON-TIMER mode selection order

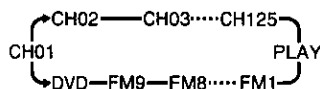

- Make sure a tape is inserted if Playback mode is selected.
- Make sure a disc is inserted if DVD(DVD/Video CD/CD) mode is selected.
- See "FM Radio" on pages 34 and 35 for instructions on how to preset FM stations.

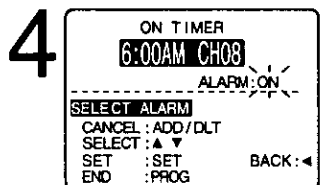

Set Alarm.

Press ▲▼ to select "ON" or "OFF."

When "ON" is selected, an alarm will gradually increase in volume for one minute or until canceled by pressing any button (including VOL + -).

To Make Corrections,

use ▲▼ and ◀▶ to move back and correct as necessary.

5 Set ON TIMER.

Press PROG/VCR+.

- "ON TIMER SET" is displayed.
- ON TIMER indicator lights on the unit.

To Cancel ON-TIMER set, repeat steps 1 and 2. Then, in step 3 press ADD/HLT to clear the time. Now, press PROG/VCR+ to end. "ON TIMER END" appears on-screen for a few seconds.

Note

If no button on the remote or unit (including a button used to turn off the alarm) is pressed within 60 minutes after unit turns itself on, it will turn itself back off.

Check list before you begin.

- The clock is set to correct time.

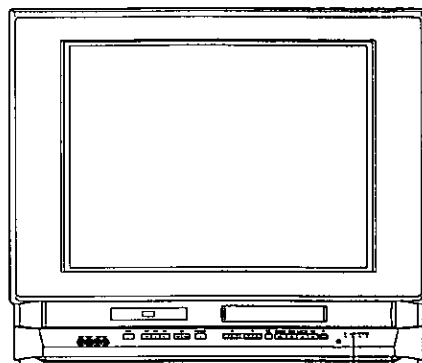

ON TIMER indicator

Sleep Timer

This unit can be set for auto power off.

a Display SET PROGRAM screen.

Press PROG/VCR+.

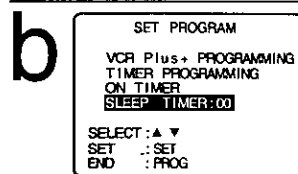

Set SLEEP TIMER.

- 1) Press ▲▼ to select SLEEP TIMER.
- 2) Press SET repeatedly to select the desired time.

SLEEP TIMER 30 → 60 → 90 → 00

To cancel, press SET repeatedly until 00 appears.

C Return to normal screen.

Press PROG/VCR+.

- Pressing DISPLAY with sleep timer set displays remaining time.

VCR Status & Clock Display

VCR Status & Clock Display



To display or remove the overlay.

Press DISPLAY.

Normal screen

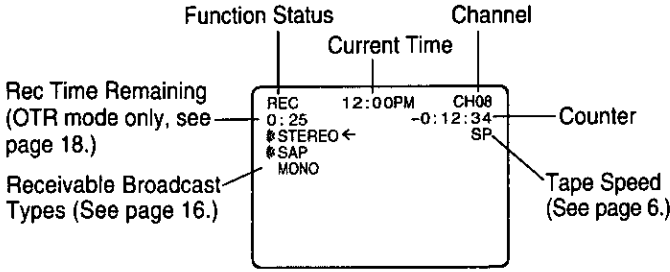

Rec Time Remaining (OTR mode only, see page 18.)
Receivable Broadcast Types (See page 16.)

Picture in Picture (PIP) screen <For Model PV-DF2700 only>

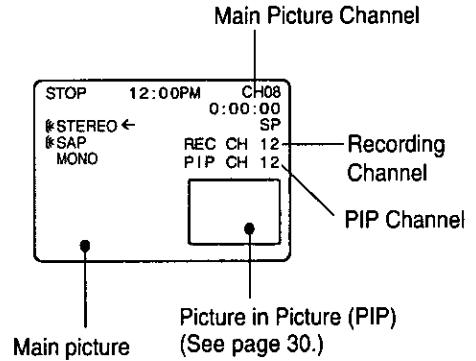

Main Picture
Recording Channel
PIP Channel
Picture in Picture (PIP) (See page 30.)

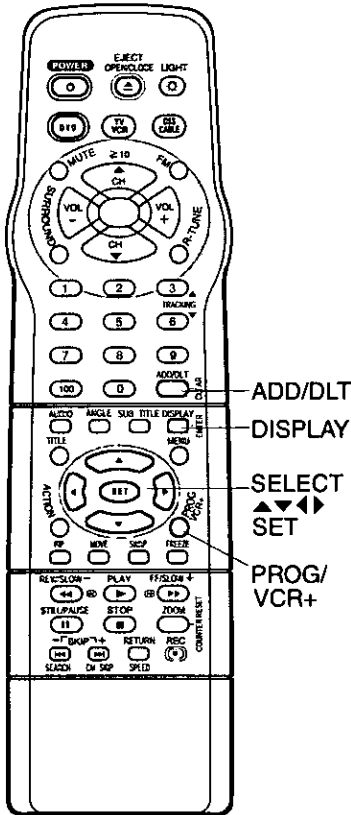

Model PV-DF2700 remote is shown here.

Blue Screen Display

Whenever a blank section of a tape comes up in Play mode, or when the selected channel has no broadcast signal with the "Weak Signal Display ON/OFF" (see page 45) set to "OFF," the TV screen will turn solid blue.

Channel & Function Display

When a function button is pressed (PLAY, FF, etc.) or you change channels, the unit mode or channel number will be displayed.

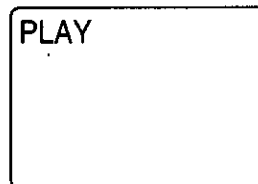
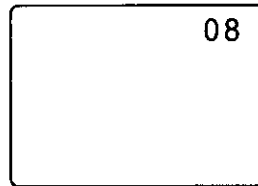

Advanced Operation

V-Chip Control Feature

V-Chip Control Feature is...

This unit has a built-in V-Chip Control which allows you to block unwanted TV usage based on US MOVIES and US TV PROGRAMS ratings.

Process of V-Chip Control Feature

Enter Code → Setup → Blocking

Enter Secret Code

A 4-digit code must be entered to view a blocked program or change rating settings.

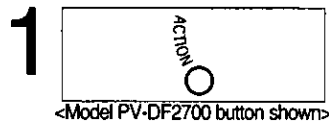

Display MAIN MENU.

Press ACTION*.

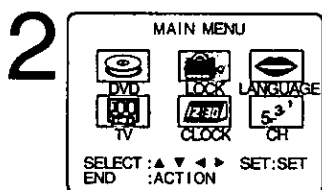

Display LOCK screen.

- 1) Press ▲▼◀▶ to select "LOCK."
- 2) Press SET to display.

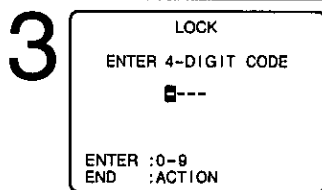
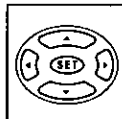

Enter your secret code.

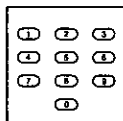

- 1) Press NUMBERED keys.
- 2) Enter same secret code again for confirmation.
- Step 2) not necessary when changing rating or secret code.
 - Take care that you are not observed entering the secret code.

To Make Corrections

Press ◀ repeatedly to move the cursor. Press NUMBERED keys to make the correction.

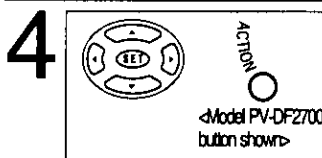

Display LOCK menu for rating screen.

Press SET and go to page 39 (US MOVIES Ratings), or page 40 (US TV PROGRAMS Ratings) page 58 (DVD LOCK Ratings) OR to exit, press ACTION twice.

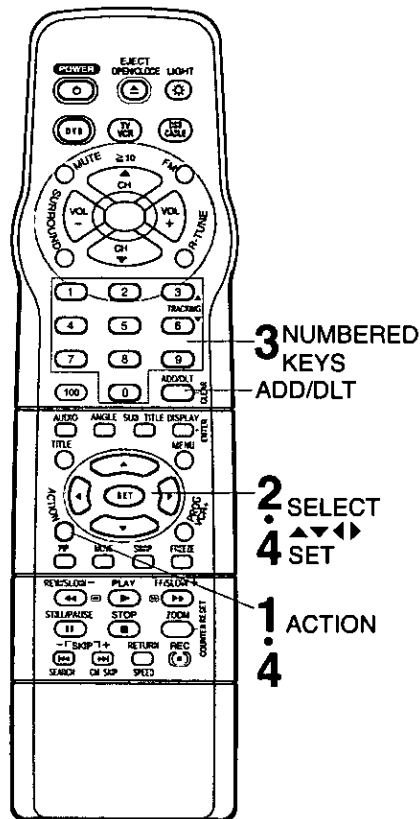

Model PV-DF2700 remote is shown here.

Change your secret code

- You will need your current code.
- Do step 1 and 2 above. Enter current secret code. Press ADD/HLT to clear the code. Do step 3 and 4 to enter new code.

Notes

- DO NOT forget your secret code.
- Once ratings are set, restricted tapes or programs cannot be accessed unless the secret code is entered.

*Important: if a remote control button does not work when pressed, press the $\sqrt{\text{CR}}$ button on the remote and try the button again.

Setup US MOVIES Ratings

If LOCK menu is not displayed, do "Enter Secret Code" steps on page 38.

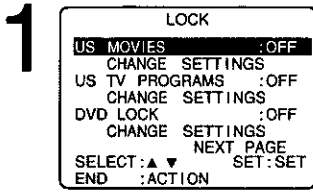

Select US MOVIES.

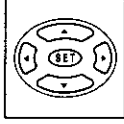

- 1) Press ▲▼ to select.
- 2) Press SET to set "ON" or "OFF."

- "ON" → V-Chip Control is activated.
- "OFF" → V-Chip Control is deactivated.

Note

- "NEXT PAGE" is setup to CANADIAN V-Chip setting mode. "NEXT PAGE" cannot be used in the U.S..

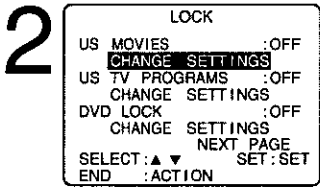

Select CHANGE SETTINGS.

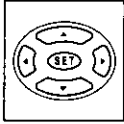

- 1) Press ▲▼ to select.
- 2) Press SET to display.

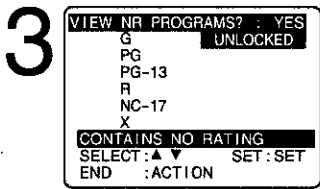

Select VIEW NR PROGRAMS?.

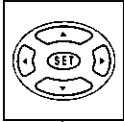

- 1) Press ▲▼ to select.
- 2) Press SET to set "YES" or "NO."

NR (Not Rated) PROGRAMS

Some movies, such as old movies or foreign movies usually have no ratings.

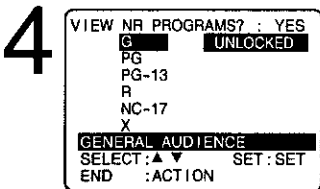

Select ratings to be blocked. (See right.)

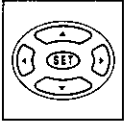

- 1) Press ▲▼ to select.
- 2) Press SET to set "LOCKED" or "UNLOCKED."

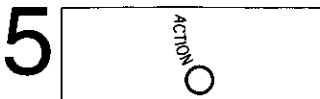

<Model PV-DF2700 button shown>

Redisplay LOCK menu to continue setup.

Press ACTION and go to page 40 (US TV PROGRAMS Ratings)

OR

to exit, press ACTION three times.

Process of V-Chip Control Feature

Enter Code → Setup → Blocking

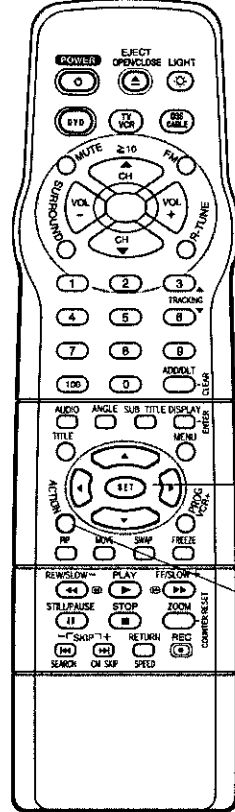

Model PV-DF2700 remote is shown here.

- 1
- 2
- 3 SELECT
- 4 SET
- 5 ACTION

US MOVIES RATINGS

G	GENERAL AUDIENCE: All ages admitted.
PG	PARENTAL GUIDANCE: Some material may not be suitable for children.
PG-13	PARENTS CAUTIONED: Some material may be inappropriate for children under 13.
R	RESTRICTED: Children under 17 must be accompanied by a parent or adult.
NC-17	OVER AGE 17 ONLY: No one 17 and under admitted.
X	ADULTS ONLY:

V-Chip Control Feature (continued)

Setup US TV PROGRAMS Ratings

Process of V-Chip Control Feature



If LOCK menu is not displayed, do "Enter Secret Code" steps on page 38.

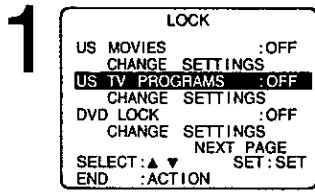

Select US TV PROGRAMS.

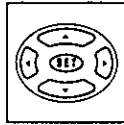

- 1) Press ▲▼ to select.
- 2) Press SET to set "ON" or "OFF."

- "ON" → V-Chip Control is activated.
- "OFF" → V-Chip Control is deactivated.

Note

- "NEXT PAGE" is setup to CANADIAN V-Chip setting mode. "NEXT PAGE" cannot be used in the U.S..

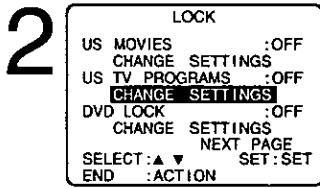

Select CHANGE SETTINGS.

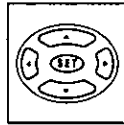

- 1) Press ▲▼ to select.
- 2) Press SET to display.

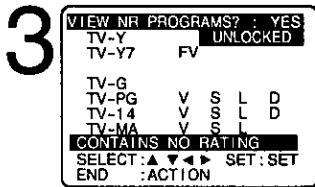

Select VIEW NR PROGRAMS?.

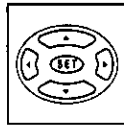

- 1) Press ▲▼ to select.
- 2) Press SET to set "YES" or "NO."

NR (Not Rated) PROGRAMS

Some TV shows, such as news, sports, weather, bulletins, emergency information usually have no ratings.

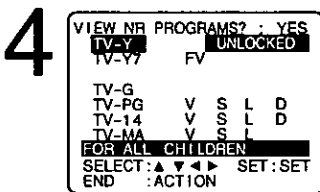

Select ratings to be blocked. (See next page.)

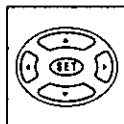

- 1) Repeatedly Press ▲▼ to select.
- 2) Press SET to set "LOCKED" or "UNLOCKED."

Note

You may select from standard TV ratings (chart 1), or customize to a specific content rating (chart 2).

- Ratings which are highlighted in Green will be blocked; those not highlighted (white letters) will not be blocked.

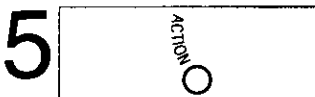

Exit this mode.

Press ACTION three times.

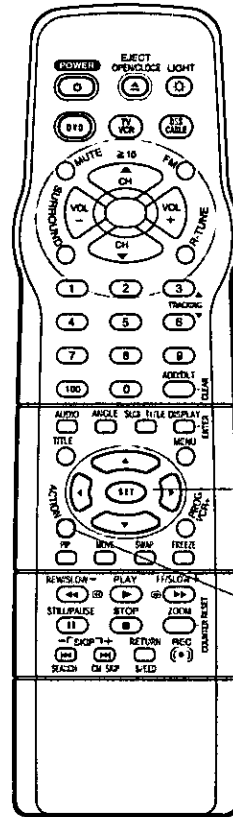

Model PV-DF2700 remote is shown here.

• Important: if a remote control button does not work when pressed, press the $\sqrt{\text{TV}}$ button on the remote and try the button again.

US TV PROGRAMS RATINGS: Chart 1

TV-Y	FOR ALL CHILDREN: Content specifically geared to young viewers ages 2-6.
TV-Y7	FOR AGE 7 AND OLDER: May contain mild physical or comedic violence which may frighten children under 7.
TV-G	GENERAL AUDIENCE: Contains little or no violence, strong language, or sexual dialogue or situations.
TV-PG	PARENTAL GUIDANCE: May contain infrequent coarse language, limited violence, some suggestive sexual dialogue and situations.
TV-14	PARENTS CAUTIONED: May contain sophisticated themes, sexual situations, strong language, and more intense violence.
TV-MA	MATURE AUDIENCE: May contain mature themes, profane language, graphic violence, and sexual situations.

US TV PROGRAMS RATINGS: Chart 2

FV	Fantasy Violence
V	Violence
S	Sexual Situations
L	Adult Language
D	Sexually Suggestive Dialogue

Process of V-Chip Control Feature

Enter Code → Setup → Blocking

Blocking Message

<When V-Chip Control is activated>

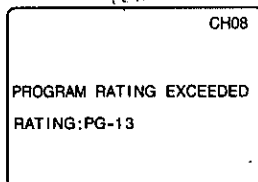

- If V-Chip Control is activated, and a program or movie exceeds the ratings you have set, a message will appear on a black background and sound is muted.

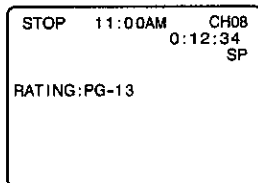

- If DISPLAY is pressed, even when V-Chip control is deactivated, rating is displayed on-screen.

To Continue Viewing a Blocked Program

After entering your 4-digit secret code, go to step 1 on both pages 39 and 40 and select "OFF" to deactivate V-Chip Control.

- The US MOVIES and US TV PROGRAMS ratings you set will be retained in memory.

Note <For Model PV-DF2700 only>

- PIP function cannot be used when V-Chip control is active.
- When the PIP picture is blocked due to the V-Chip feature, the PIP screen turns black while the Main Picture continues to be displayed.

Tape Operation

Commercial Skip

By pressing the CM SKIP button in Play mode, you can skip over 1 to 3 minutes of recorded tape in just a few seconds.



Set Skip Time.

Press CM SKIP* repeatedly to select skip time as follows.

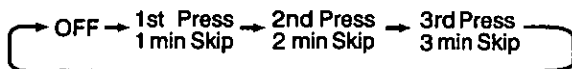

Program End Search

Each time a recording is made, an invisible index mark is placed on the tape. This allows you to easily search for the end of your recordings to continue or start a new recording.



Display SELECT SEARCH MODE in Playback or Stop mode.

Press SEARCH on the remote.

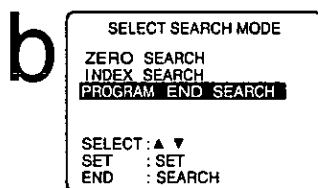

Display PROGRAM END SEARCH.

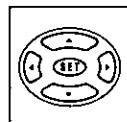

- 1) Press ▲▼ to select.
- 2) Press SET to start search.

Example of Program End Search operation.

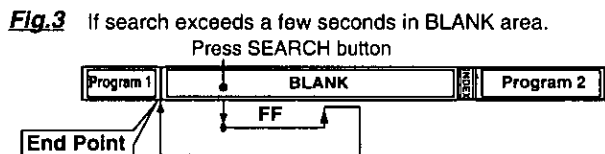
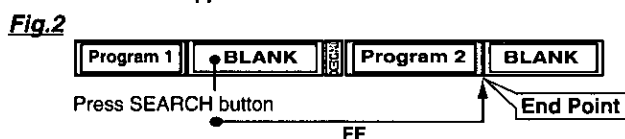
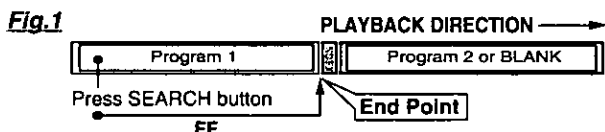

If Program End Point is found.

The search continues slightly beyond the end point, then search and reverse search and plays the last few seconds of the program and finally stop.

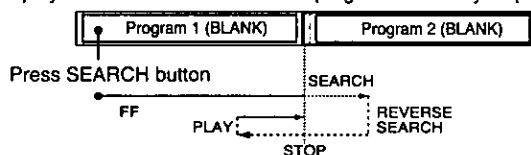

Your unit is equipped with several time saving features as well as convenient automatic functions which make tape operation easier than ever.

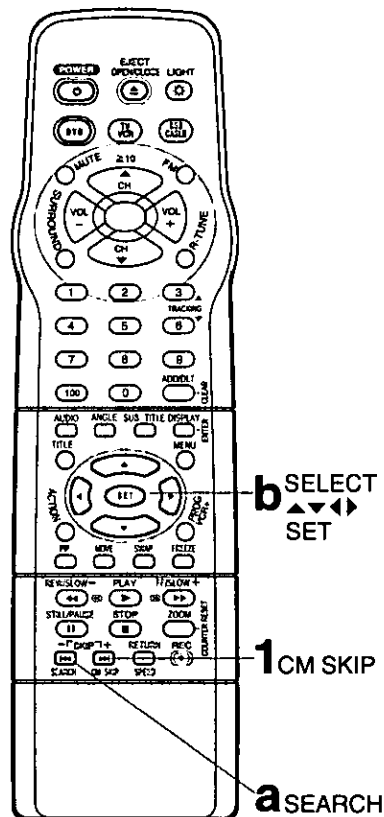

Model PV-DF2700 remote is shown here.

Repeat Play

Set to see a recording over and over.

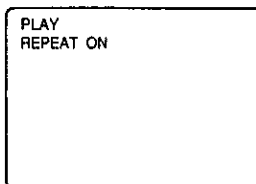

To turn "ON," press PLAY/REPEAT on the unit repeatedly in Play mode to select "REPEAT ON".

To turn "OFF," repeat above to select "REPEAT OFF."

- Playback repeats when tape end is reached or unrecorded portion over 30 seconds is detected.

Note

- For repeat play in DVD mode, see page 57.

Notes

- If Program End Search is started very close to an index mark, one program may be skipped over.
- If you want to cancel Program End Search, Press PLAY or STOP.

*Important: if a remote control button does not work when pressed, press the  button on the remote and try the button again.

VHS Index Search System is ...

Each time recording is made, an invisible index mark is placed on the tape. When timer recordings are made, program index and information are also included. These index marks can be used to access or scan recordings.

Direct Access (For Normal and/or Timer recordings)

Go directly to the desired recording.



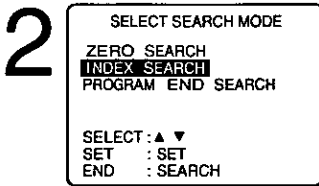

Display SELECT SEARCH MODE screen.
Press SEARCH in Playback or Stop mode.

- If there are no Timer Recordings on the Program Index List, go to step 3.

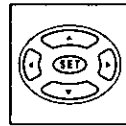

Display INDEX screen.



- 1) Press   to select "INDEX SEARCH."
- 2) Press SET to display.



Select the recording number.

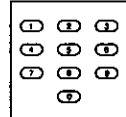

Press **NUMBERED** keys.

- To calculate number, see below.

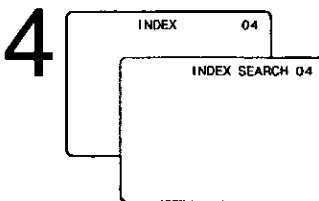

Start search.

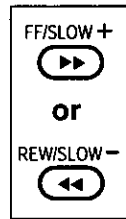

Press FF or REW.
• When search is finished, playback begins.

To calculate the Index Number

Example 1:

If you are watching recording 4 and you want to watch recording 2, enter "3" in step 3 and press REW.

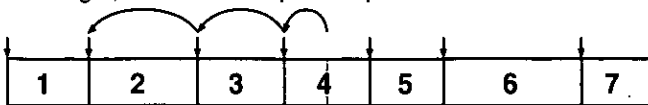

Example 2:

If you are watching recording 2 and you want to watch recording 6, enter "4" in step 3 and press FF.

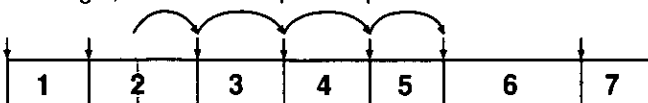

NOTE: ↓ indicates start points of each recording.

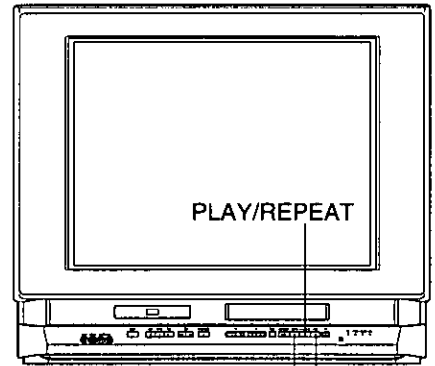

4 REW 4 FF

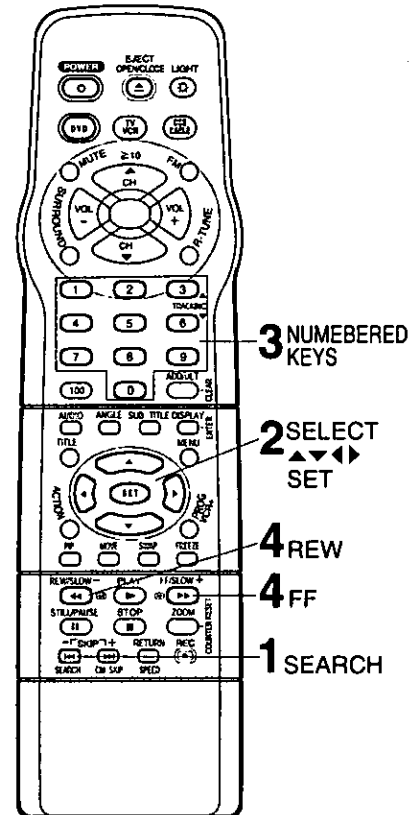

Model PV-DF2700 remote is shown here.

Notes

- Make each entry within 10 seconds, or the Index Search mode will be canceled.
- If Direct Access or Index Scan search is started very close to an index mark, that index mark may not be counted in the search.



Tape Operation (continued)

Index Scan (For Normal and/or Timer recordings)

In Play mode, the first 10 seconds of each recording can be scanned (forward or reverse).

A Repeat step 1 and 2 on page 43 to display the INDEX screen.

B  **Start the scan.**
Press FF or REW.

FF/SLOW+ 
or
REW/SLOW- 

C  **Cancel scan, start playback.**
Press PLAY.

 • To stop, press STOP. (See example right.)

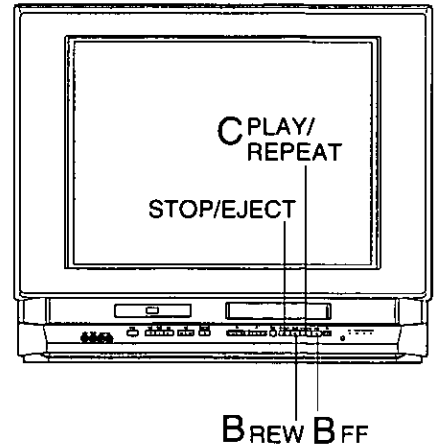

<Example>

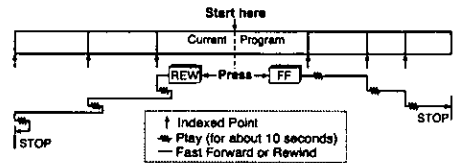

Zero Search

To quickly return to a specific tape counter location.

a  **Display the Counter.**
Press DISPLAY* during playback.

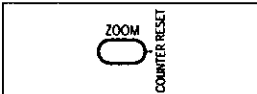
b  **Reset to "0:00:00."**
Press COUNTER RESET at the desired position.

c Continue playback, rewind, or fast forward.

d  **Display SELECT SEARCH MODE in Stop mode.**
Press SEARCH.

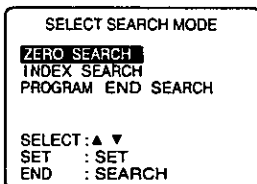
e  **Select ZERO SEARCH.**

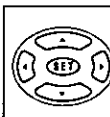
 1) Press ▲▼ to select.
2) Press SET to start search.

Return to "0:00:00."

• Unit will go into FF or REW mode and stops at the last point the Counter was set to 0:00:00.

Auto Operation Functions

- **Auto Shut Off**
If no broadcast signal in TV, DVD stop, or Playback mode for 5 min.,
→ Power turns off automatically
• This feature is deactivated if any button is pressed during the above mode.
- **Auto Playback**
A tape is inserted in Power off mode,
→ Power turns on automatically
→ Playback starts if no rec. tab
- **Auto Rewind**
A tape reaches its end,
→ Rewind begins
→ Tape stops
- **Playback Auto Eject (Repeat Play is "OFF")**
A tape with no rec. tab reaches its end,
→ Rewind begins
→ Tape ejects
- **Memory Rewind off**
POWER is pressed in REW mode,
→ TV Power shuts off (rewind continues)
→ Rewind completes
→ All power shuts off

Special VCR Features

*Important: if a remote control button does not work when pressed, press the **VCR** button on the remote and try the button again.

✓ Check list before you begin.

- It is necessary to enter TV mode by pressing **TV** before selecting "CH" on the MAIN MENU.

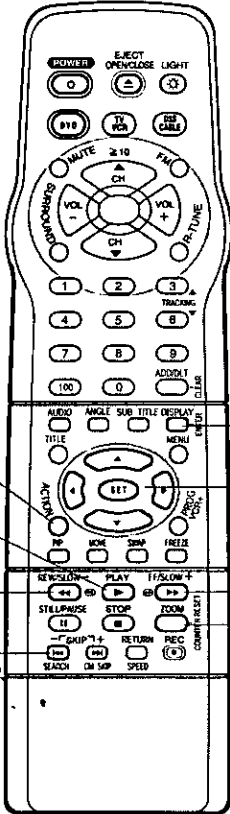

Model PV-DF2700 remote is shown here.

Weak Signal Display ON/OFF

When "ON" is selected, the picture is displayed even when a broadcast signal is weak or non-existent.

1  **Display MAIN MENU.**
Press ACTION.
<Model PV-DF2700 button shown>

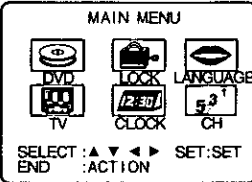
2  **Display SET UP CHANNEL screen.**
1) Press **▲▼◀▶** to select "CH."
2) Press **SET** to display.

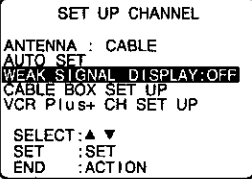
3  **Select WEAK SIGNAL DISPLAY.**
1) Press **▲▼** to select.
2) Press **SET** to set "ON" or "OFF."

Notes

- "ON" = Picture is displayed regardless of signal condition, and may not always be clearly visible.
- "OFF" = Screen turns solid blue when signal is absent or weak.
- If unit is connected to equipment which has blue back feature, selecting "ON" will have no effect on the other equipment.

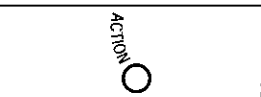
4  **Return to the normal screen.**
Press ACTION twice.
<Model PV-DF2700 button shown>

VCR Lock

All operations are prohibited except Timer recording and tape eject. Useful for families with small children.

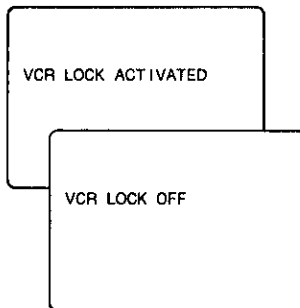

VCR LOCK ACTIVATED

VCR LOCK OFF

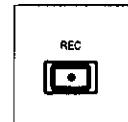

To turn "ON."
In stop mode, hold down REC on the unit without a cassette inserted for 7 seconds.

To turn "OFF."
Repeat above with or without cassette.

- VCR Lock is canceled automatically after about 24 hours if clock is set.

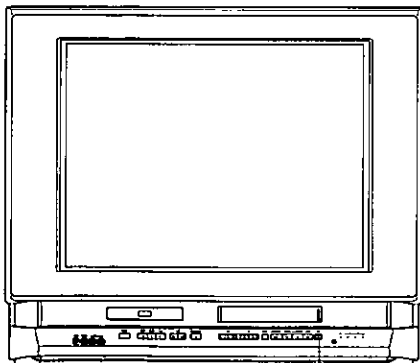

REC

Audio Features

Select Audio Mode for Playback

Choose the type of sound track for playback.

1 Playback the tape.

See the "Playback a Tape" section on page 17.

2

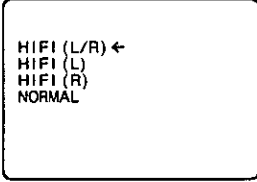

HIFI (L/R) ←
HIFI (L)
HIFI (R)
NORMAL

- This screen appears when you press AUDIO during playback.

Select desired mode.



AUDIO

Press AUDIO* repeatedly (each press within 5 seconds.)

- Please select "HIFI (L/R)", "HIFI (L)" or "HIFI (R)" to listen to stereo recordings in stereo sound. Select "NORMAL" for monaural sound.

With the proper audio mode setting, your unit can:

- record and playback MTS stereo broadcast (main language) in stereo Hi-Fi. Stereo sound is recorded on the left and right audio tracks and on the video portion of a tape.
- record and playback a monaural broadcast (main language) or SAP (Secondary Audio Program, usually in a second language) on the Hi-Fi tracks for better quality monaural sound.
- playback non-Hi-Fi tapes in monaural.

Select Audio Mode for Recording

Choose the type of broadcast to be recorded.

a



AUDIO

Select Audio Mode for recording. Press AUDIO.

Recording is always made in the audio mode selected in the "Select Audio Mode for TV Viewing" section on page 16.

b

Do a recording.

See the "Record On a Tape" section on page 18.

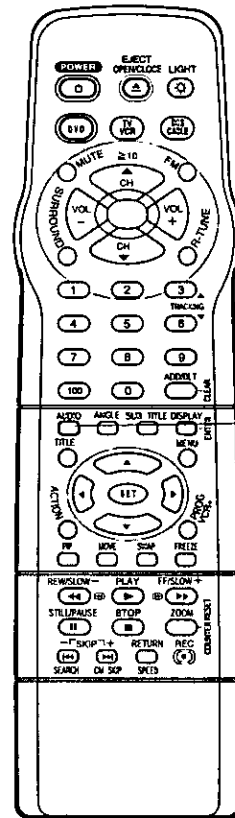

Model PV-DF2700 remote is shown here.

Notes

- When purchasing or renting prerecorded tapes, remember that only those recorded in Hi-Fi stereo will playback with true stereo sound. Standard stereo tapes will playback with monaural sound.
- To listen to the superior sound of Hi-Fi stereo playback, the unit AUDIO (L/R) jacks must be connected to a stereo amp and speakers.
- There may be a difference in audio level between Hi-Fi and normal audio playback.

*Important: if a remote control button does not work when pressed, press the TV button on the remote and try the button again.

Speaker ON/OFF System

You can turn off the unit speaker when it is connected to external audio equipment.

1  **Display MAIN MENU.**
Press ACTION.

<Model PV-DF2700 button shown>

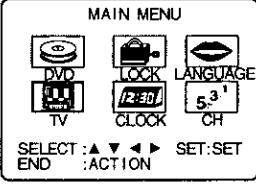
2  **Display SET UP TV screen.**

 1) Press $\blacktriangle\blacktriangleright\blacktriangleleft\blacktriangledown$ to select "TV."
2) Press SET to display.

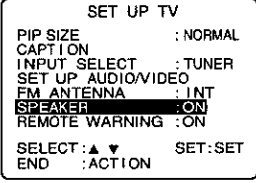
3  **Select SPEAKER.**

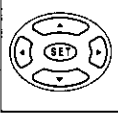
 1) Press $\blacktriangle\blacktriangledown$ to select.
2) Press SET to set "ON" or "OFF."

<Model PV-DF2700 screen shown>

• In SPEAKER OFF condition, the MUTE button and VOL +/- do not function.

4  **End setup.**
Press ACTION twice.

<Model PV-DF2700 button shown>

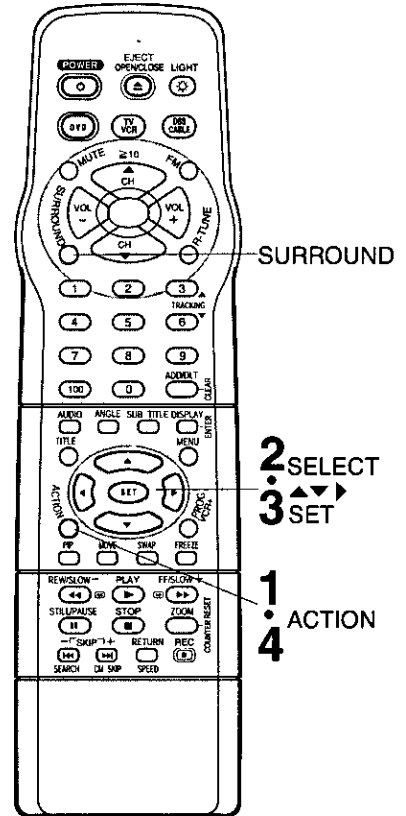

Model PV-DF2700 remote is shown here.

Surround Sound system

You can hear a deeper, 3-D sound effect using just the unit's two front speakers.

Set Surround sound.

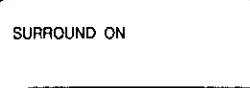
 Press SURROUND.
• "SURROUND ON" will be displayed.

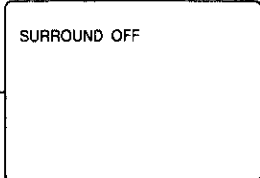
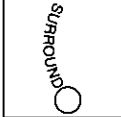
To Cancel, press SURROUND.

Notes

- Surround sound effect is not available for normal (mono) broadcasts.
- The surround effect (TV, VCR mode only) is not output to Audio Output L/R Connector.

*Important: if a remote control button does not work when pressed, press the TV button on the remote and try the button again.

This feature allows easy setting of picture and sound suitable for each program source.

Audio Menu

1 Display MAIN MENU.
Press ACTION*.

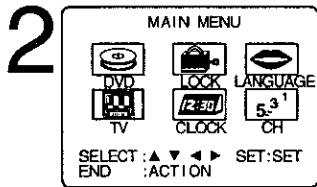

2 Display SET UP TV screen.

- 1) Press ▲▼◀▶ to select "TV."
- 2) Press SET to display.

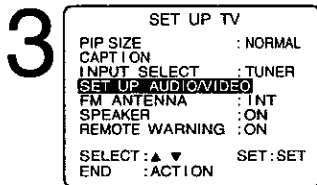

3 Display SET UP AUDIO/VIDEO screen.

- 1) Press ▲▼ to select.
- 2) Press SET to display.

<Model PV-DF2700 screen shown>

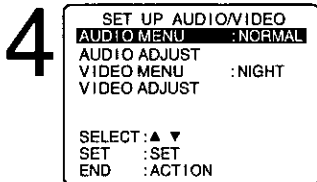

4 Select AUDIO MENU.

- 1) Press ▲▼ to select.
- 2) Press SET to set AUDIO MENU.
(See below.)

5 End setup.
Press ACTION three times to exit.

[Audio Menu]

■ NORMAL

Factory setting

■ AUTO

[Audio AGC (Auto Gain Control)]

The sound level are automatically adjusted to suit the program source (see right.)

■ MOVIE

Sound suited to movies.

■ MUSIC

Sound suited to music.

■ SPEECH

Sound suited to dialog.

Notes

- The effects of this feature on the signal is not output to the Audio/Video Output Connector.
- When AUDIO MENU mode is "AUTO," the AUDIO ADJUST setting will be "STANDARD."
- AUDIO MENU settings remain in memory.
- VIDEO MENU settings do not remain in memory.

Video Menu

a Do steps 1 - 3 left.

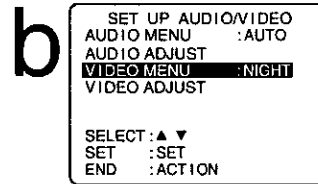

Select VIDEO MENU.

- 1) Press ▲▼ to select.
- 2) Press SET to set VIDEO MENU.
(See below.)

C End setup.
Press ACTION three times to exit.

[Video Menu]

■ NORMAL

Factory setting.

■ MOVIE

Picture is adjusted for a Movie-like feel.

■ NIGHT

Color and picture intensity is adjusted to be easier on the eyes for night viewing.

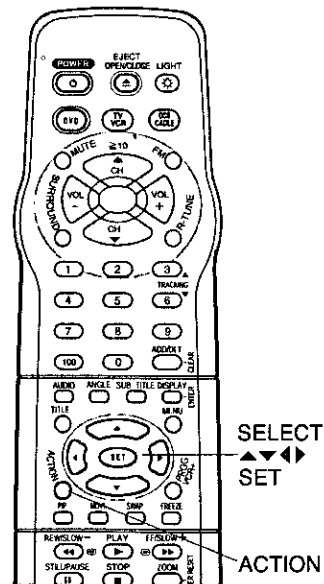

Model PV-DF2700 remote is shown here.

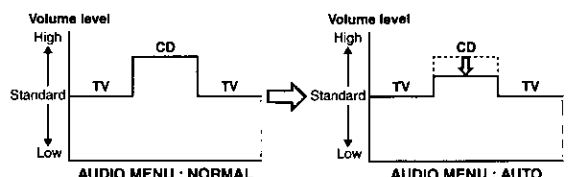

<Audio AGC Example>

Audio / Video Adjustment

Video Adjustment

1 Display MAIN MENU.
Press ACTION.

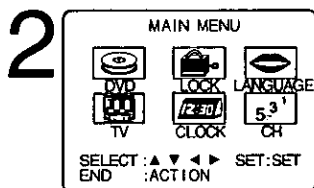

Display SET UP TV screen.

- 1) Press ▲▼◀▶ to select "TV."
- 2) Press SET to display.

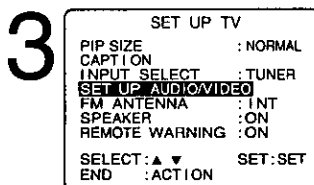

Display SET UP AUDIO/VIDEO screen.

- 1) Press ▲▼ to select.
- 2) Press SET to display.

<Model PV-DF2700 screen shown>

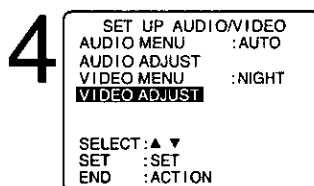

Select VIDEO ADJUST screen.

- 1) Press ▲▼ to select.
- 2) Press SET to display.

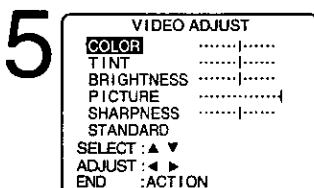

Adjust desired item.

- 1) Press ▲▼ to select an item.
(See below right.)
- 2) Press ◀▶ to adjust.

To Reset VIDEO Controls.

Press ▲▼ and SET to select and set "STANDARD." All controls return to their factory settings.

6 End setup.
Press ACTION four times to exit.

[VIDEO Adjustment]

■ COLOR Control

Adjust color intensity.

■ TINT Control

Adjust for natural flesh tones.

■ BRIGHTNESS Control

Adjust picture brightness.

■ PICTURE Control

Adjust picture intensity by adjusting both contrast and color level in the proper balance.

■ SHARPNESS Control

Adjust picture sharpness.

Audio Adjustment

a Display MAIN MENU.
Press ACTION.

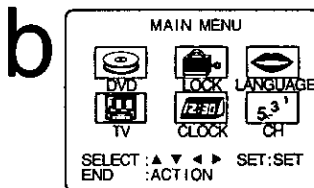

Display SET UP TV screen.

- 1) Press ▲▼◀▶ to select "TV."
- 2) Press SET to display.

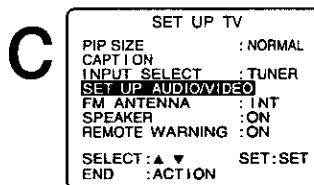

Display SET UP AUDIO/VIDEO screen.

- 1) Press ▲▼ to select.
- 2) Press SET to display.

<Model PV-DF2700 screen shown>

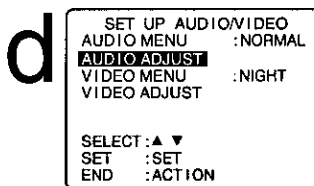

Select AUDIO ADJUST screen.

- 1) Press ▲▼ to select.
- 2) Press SET to display.

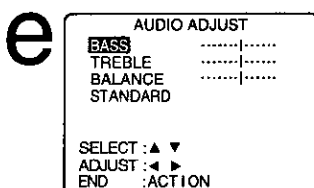

Adjust desired item.

- 1) Press ▲▼ to select an item.
(See below right.)
- 2) Press ◀▶ to adjust.

To Reset AUDIO Controls.

Press ▲▼ and SET to select and set "STANDARD." All controls return to their factory settings.

f End setup.
Press ACTION three times to exit.

Note

- When AUDIO MENU mode is "AUTO," the AUDIO ADJUST setting will be "STANDARD."

[AUDIO Adjustment]

■ BASS Control

To adjust the intensity of low frequency sound.

■ TREBLE Control

To adjust the intensity of high frequency sound.

■ BALANCE Control

To adjust the (L/R) unit speaker output level.

- The levels set here do not affect other audio equipment when connected to the Audio Output L/R Connector.

Disc Operation

Changing subtitle language (DVD only)

You can select a different subtitle language (if offered) than the one set at the Settings for DVD Operation. (See page 59.)

1

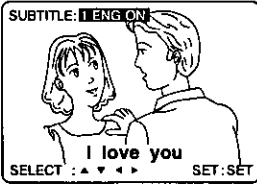

Display the subtitle screen.

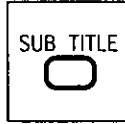

Press SUB TITLE* in play mode.

- When no subtitles are offered, "-" will be displayed instead of the language number.

2

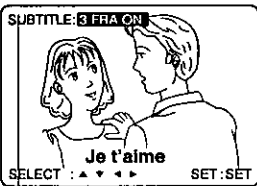

Set the desired language.

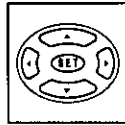

- 1) Press ▲▼ to select language.
- 2) Press ► (or ◀) to set.
- 3) Press ▲ (or ▼) to select "ON" or "OFF."

Number of subtitle language being played back.

To return to the normal screen, Press SUB TITLE.

Notes

- When closed captioning is used along with subtitles, they may overlap. If so, turn one function off. (See pages 32 and 33.)
- If, after several presses of the button the language does not change, language selection is not offered on the disc.
- Subtitles may not change to the selected language immediately.
- When power is turned on or disc is removed, subtitles revert to initial setting language. If the initial language is not recorded on the disc, the disc's priority language will appear.

Changing audio soundtrack language (DVD only)

You can change the audio soundtrack language, selected at the Settings for DVD Operation, to a different language if available. (See page 59.)

(This operation works only with discs on which multiple audio soundtrack languages are recorded.)

a

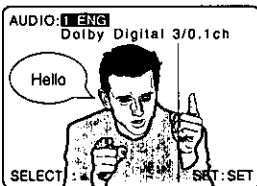

Display the audio screen.



Press AUDIO in play mode.

Audio attribute 1 type, sampling frequency, bit No. of the disc.

b

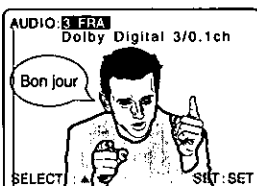

Select the desired language.

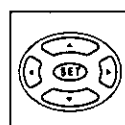

Press ▲▼ to select desired language.

To return to the normal screen, Press AUDIO.

Number of the audio soundtrack language being played back.

Check list before you begin.

Please read "Basic DVD Operation" on page 20.

[Subtitle language (No.)]

[Audio sound track language (No.)]

ENG	English
FRA	French
DEU	German
ITA	Italian
ESP	Spanish
NLD	Dutch
SVE	Swedish
NOR	Norwegian
DAN	Danish
POR	Portuguese
RUS	Russian
JPN	Japanese
CHI	Chinese
KOR	Korean
MAL	Malay
VIE	Vietnamese
THA	Thai
*	Other

• Change the No. by pressing ▲▼, and press SET.

[Audio attribute 1 type, sampling frequency, bit No. of the disc (see page 60)]

LPCM	96KHz or 48KHz	16bit	Linear PCM disc
		20bit 24bit	
AC-3	1ch - 5.1ch	Dolby Digital (AC-3) disc	
DTS	1ch - 5.1ch	DTS disc	

Notes

- If, after several presses of the button the language does not change, language selection is not offered on the disc.
- When power is turned on or disc is removed, language reverts to initial setting. If this language is not recorded on the disc, the language recorded will be heard.

• Important: if a remote control button does not work when pressed, press the DVD button on the remote and try the button again.

When  appears on the screen while a button is being operated, it means that the corresponding operation is prohibited by the unit or the disc.

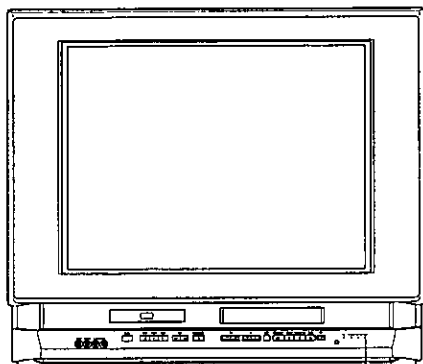

ANGLE indicator

Notes

- The angle number can be set beforehand so that the angle is switched whenever ANGLE lights.
- ANGLE lights on the unit when a scene recorded at different angles is detected.

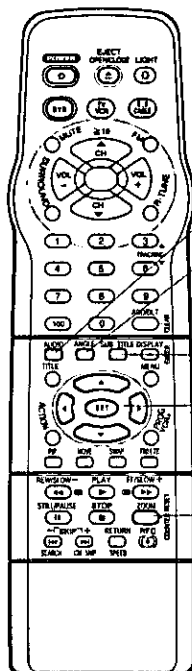

Model PV-DF2700 remote is shown here.

Notes

- Closed captioning will not be displayed while Picture Zoom is used. To see subtitles, set the subtitle feature to ON (see page 50.)
- The subtitle position cannot be changed. The subtitle cannot be enlarged.
- The Zoom feature may not work with the menu screen.
- The picture zoom feature does not work with a Video CD.
- During picture zoom, "ZOOM1" or "ZOOM2" is displayed on the screen.

Multiple angle viewing (DVD only)

DVDs may contain scenes shot from multiple camera angles allowing the same scene to be viewed at different angles. For these discs, the same scene can be viewed from each of these angles, if available, can be viewed using the ANGLE button.

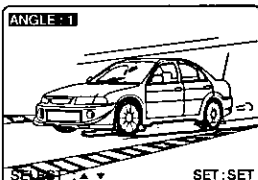
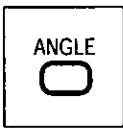
1  **Display the angle screen.**
 Press ANGLE in play mode.

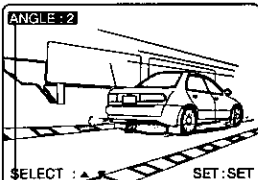
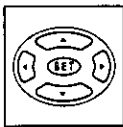
2  **Select the desired angle.**
 Press \blacktriangle / \blacktriangledown to select.
To return to the normal screen, Press ANGLE.

Vocal selection for Karaoke discs (DVD/Video CD)

a  **Display the audio screen.**
 Press AUDIO in play mode.

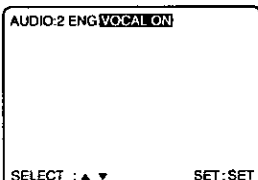
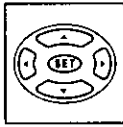
b  **Select the desired setting.**
 1) Press \blacktriangle / \blacktriangledown (or \blacktriangleleft / \blacktriangleright) to select.
 2) Press \blacktriangleright (or \blacktriangleleft) to set. (DVD only)

- DVD Karaoke (1 vocal) VOCAL ON \leftrightarrow VOCAL OFF
- DVD Karaoke (2 vocals) VOCAL V1 + V2 \leftrightarrow VOCAL V1 \leftrightarrow VOCAL V2 \leftrightarrow VOCAL OFF
- Video CD $\text{LR} \leftrightarrow \text{L} \leftrightarrow \text{R}$

Picture Zoom (DVD only)

You can enlarge specific portions of a picture and select the zoom ratio using the ZOOM button on the remote during DVD playback.

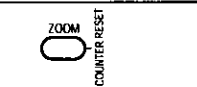
 **Set Zoom size.**
 Press ZOOM repeatedly to change display as follows.

- You can enlarge the center portion of the image to one of 2 magnifications.

X 1.0 (ORIGINAL) X 1.5 (ZOOM 1) X 2.0 (ZOOM 2)

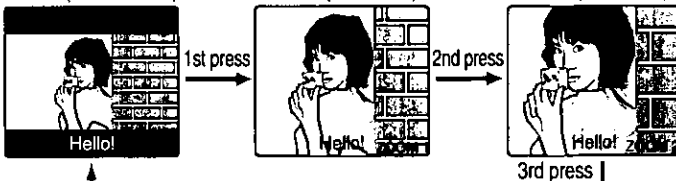

- Use the \blacktriangle and \blacktriangledown buttons to move the position up and down.
- Use the \blacktriangleleft and \blacktriangleright buttons to move the position left and right.
- Depending on the disc, operating the zoom may result in poor picture quality. In this case, turn zoom off.

Disc Operation (continued)

Using a title menu (DVD only)

Some DVDs have more than one title, e.g. movies.
If the disc offers a title menu, you can select the desired title number.
(Operation may vary according to the disc.)

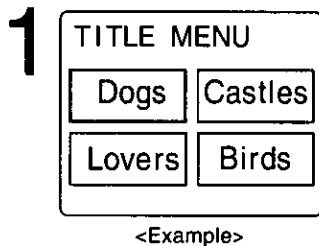

Display the title screen.

Press TITLE* in play mode.

- Pressing TITLE again resumes play from the scene when TITLE was first pressed.

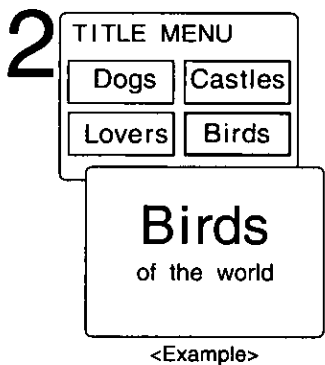

Select the desired title.

1) Press ▲▼◀▶ or NUMBERED Key(s) to select.

2) Press SET or PLAY to start playing.

- Step 2) not necessary when using NUMBERED key(s).

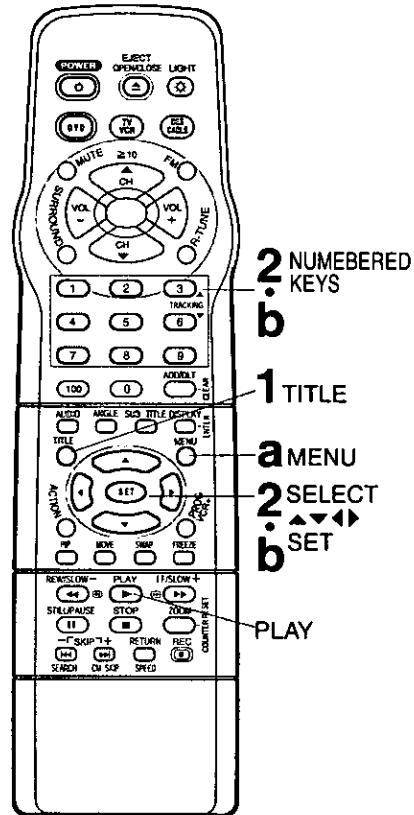

Model PV-DF2700 remote is shown here.

Using a DVD menu (DVD only)

DVDs may offer a special menu. This menu may include guides to unique contents, audio/subtitle languages, etc.
Although contents and operation may vary, the following steps show basic steps for using the menu.

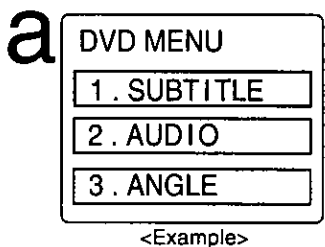

Display the DVD menu.

Press MENU in play mode.

- Pressing MENU again resumes play from the scene when MENU was first pressed.

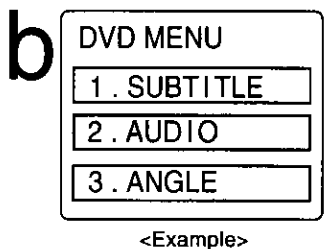

Select the desired item.

1) Press ▲▼◀▶ or NUMBERED Key(s) to select.

2) Press SET or PLAY to perform.

- Step 2) not necessary when using NUMBERED key(s).

If menu continues onto another screen, repeat step b.

Note <For Model PV-DF2700 only>

- TITLE MENU cannot be operated if displayed on the PIP. Press SWAP to switch it to Main Picture, then operate.

* Important: if a remote control button does not work when pressed, press the $\sqrt{\text{TV}}$, DVD button on the remote and try the button again.

Check list before you begin.

- It is necessary, press $\sqrt{\text{TV}}$ to enter TV mode.
- Video CD or CD is inserted.

Program Play (Video CD/CD)

You can program specific tracks and order of play.

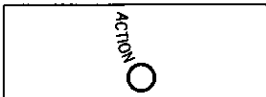
1  **Display MAIN MENU.**
Press ACTION in stop mode.

<Model PV-DF2700 button shown>

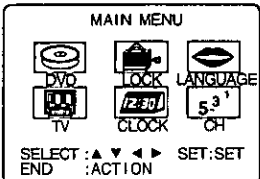
2  **Display DVD screen.**

1) Press $\blacktriangle\blacktriangledown\blacktriangleleft\blacktriangleright$ to select "DVD."
2) Press SET to display.

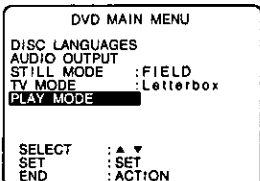
3  **Select PLAY MODE.**

1) Press $\blacktriangle\blacktriangledown$ to select.
2) Press SET to display.

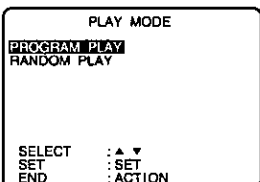
4  **Select PROGRAM PLAY.**

1) Press $\blacktriangle\blacktriangledown$ to select.
2) Press SET to display.

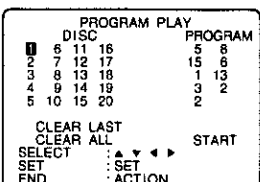
5  **Select desired track number. (Track numbers on disc are displayed.)**

1) Press $\blacktriangle\blacktriangledown\blacktriangleleft\blacktriangleright$ to select.
2) Press SET to set.

- Repeat step 5 to select another track.
- The selected track is added on the right side.

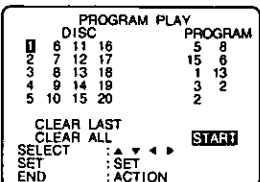
6  **Start PROGRAM PLAY.**

1) Press $\blacktriangle\blacktriangledown\blacktriangleleft\blacktriangleright$ to select "START."
2) Press SET.

- Play begins in the programmed sequence.
- To cancel, press STOP during play and then press CLEAR.

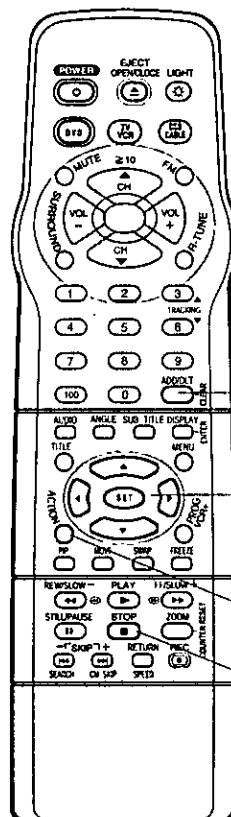

Model PV-DF2700 remote is shown here.

Notes

- Up to 15 tracks can be programmed.
- " \blacktriangleleft " or " \blacktriangleright " (depending on disc) indicates additional PROGRAM PLAY screen. Press $\blacktriangle\blacktriangledown\blacktriangleleft\blacktriangleright$ for next or previous screen.
- To clear the last program one by one Press $\blacktriangle\blacktriangledown\blacktriangleleft\blacktriangleright$ to move to "CLEAR LAST" and press "SET."
(Pressing CLEAR on remote control also clears last program.)
- To clear all programs Press $\blacktriangle\blacktriangledown\blacktriangleleft\blacktriangleright$ to move to "CLEAR ALL" and press "SET."
(Programs are also cleared when the power is turned off or the disc is removed.)

PROGRAM REPEAT PLAY

Press PLAY/REPEAT in PROGRAM PLAY mode and $\blacktriangle\blacktriangledown$ to select "PROGRAM REPEAT."
To cancel, repeat this to select "REPEAT OFF."

*Important: If a remote control button does not work when pressed, press the $\sqrt{\text{CD}}$ DVD button on the remote and try the button again.

Random Play (Video CD/CD)

Tracks are played in a random order.

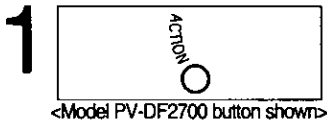

Display MAIN MENU.

Press ACTION* in stop mode.

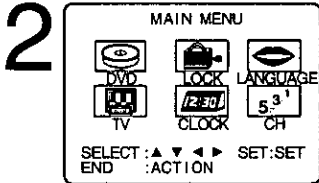

Display DVD screen.

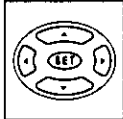
- 
- 1) Press ▲▼◀▶ to select "DVD."
 - 2) Press SET to display.



Select PLAY MODE.

- 
- 1) Press ▲▼ to select.
 - 2) Press SET to display.

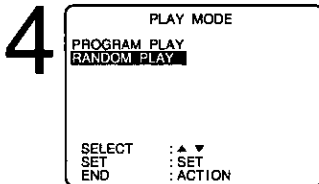

Select RANDOM PLAY.

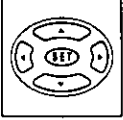
- 
- 1) Press ▲▼ to select.
 - 2) Press SET.
- Random play begins.
 - To cancel, press STOP during play and then press CLEAR.

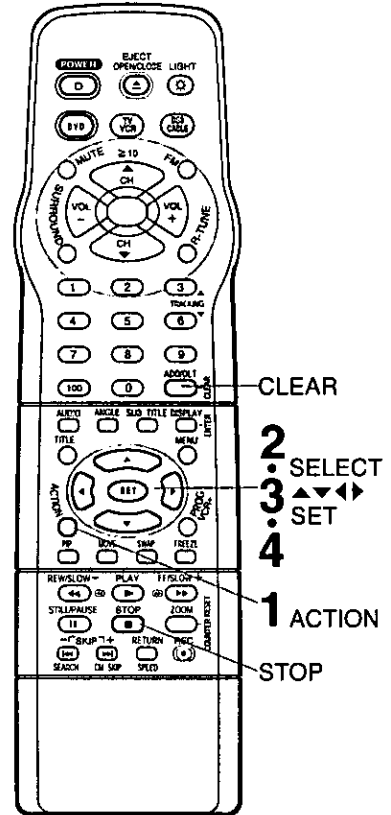

DVD Operation using On-Screen Displays

When DISPLAY is pressed, On-Screen Displays show disc information (title/chapter/track number, elapsed playing time) and unit information (repeat play, play mode).

- Check list before you begin.**
- It is necessary, press DVD to enter DVD mode.

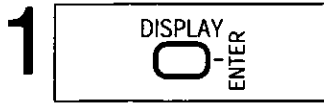

Display On-Screen Displays.

Press DISPLAY in play or stop mode.

- Each time DISPLAY is pressed, On-Screen Display changes as shown below (refer to page 56 or 57.)

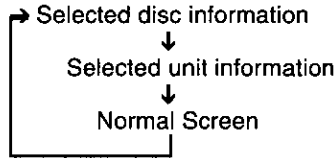

Note

DISPLAY button does not function while DVD TITLE MENU is displayed.

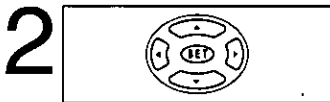

Select the desired item.

- 1) Press ▲▼ (or ◀▶) to select.
- 2) Press SET to set.

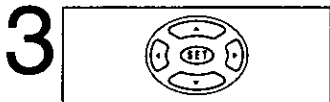

Select the desired setting.

- 1) Press ▲▼ to select.
- 2) Press SET to set.

<Example of DVD>

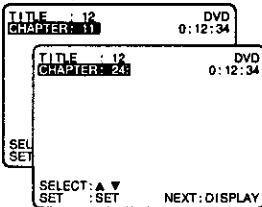

- For some functions the setting will be registered immediately without pressing SET.
- When numbers are displayed (e.g. title number), the NUMBERED keys are also available.

To make corrections, repeatedly press ▲▼ and SET to move to error, then correct.

- Pressing ◀ is effective for elapsing time instead of the above buttons. Press ◀ repeatedly to delete the error, then correct.

<Example of Video CD>

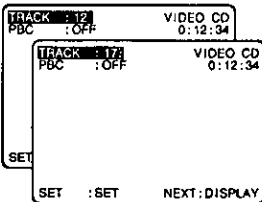

To return to the normal screen, press RETURN or DISPLAY repeatedly.

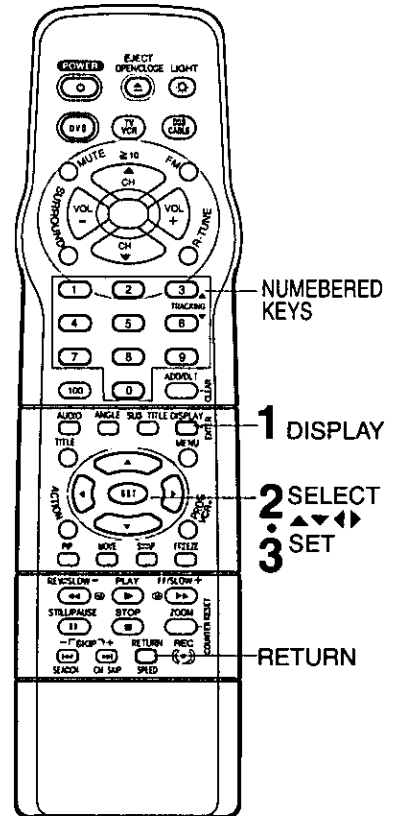

Model PV-DF2700 remote is shown here.

Advanced Operation

Note

When DISPLAY button is pressed during playback of a Video CD with Playback control, the NUMBERED keys are not available on the displayed screen. In this case, press DISPLAY again to remove the displayed screen.

- When a button with a circle and slash symbol appears on the screen while a button is being operated, it means that the corresponding operation is prohibited by the unit or the disc.

Detailed descriptions of each On-Screen Display

Disc information screen (For DVD)

1. TITLE No.

- Change the No. by pressing ▲▼* or the NUMBERED keys, and press SET.

2. Chapter No.

- Change the No. by pressing ▲▼ or the NUMBERED keys, and press SET.

3. Disc currently being played

4. Elapsed playing time

The screen may be changed by selecting the elapsed time.

- Change the elapsed time by pressing NUMBERED keys.

(ex) 01 : 23 : 45 0 → 1 → 2 → 3 → 4 → 5

- This function does not work with some discs.

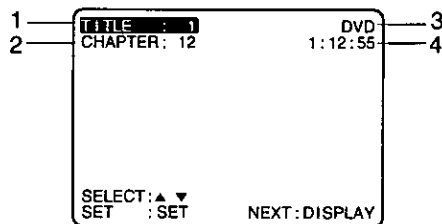

Disc information screen (For Video CD/CD)

A. Track No.

- Change the No. by pressing ▲▼ or the NUMBERED keys, and press SET.

B. Playback control ON/OFF

[Video CD with playback control only]

ON	Video CD menu play is displayed.
OFF	Video CD menu play is cleared.

C. Disc currently being played

Video CD	CD
----------	----

D. Elapsed playing time

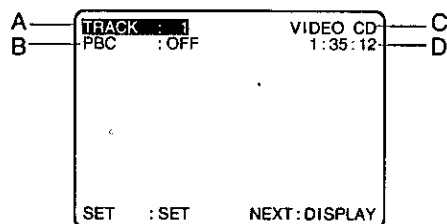

Note

Track NO. and the elapsed playing time are not displayed during menu play of Video CDs with playback control.

- When ⊘ appears on the screen while a button is being operated, it means that the corresponding operation is prohibited by the unit or the disc.

Detailed descriptions of each On-Screen Display

Unit information screen (For Unit)

- Change the desired mode during play by pressing ▲▼, and press SET.

a. Repeat Play

DVD	CHAPTER REPEAT	TITLE REPEAT	REPEAT OFF
Video CD/CD	TRACK REPEAT	DISC REPEAT	REPEAT OFF

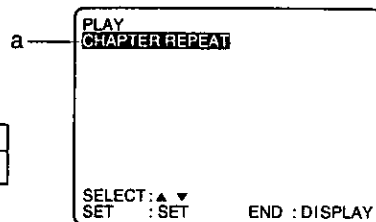

b. Play mode [Video CD/CD only] (See pages 53 or 54.)

PROGRAM PLAY	program play
RANDOM PLAY	random play
-	normal play

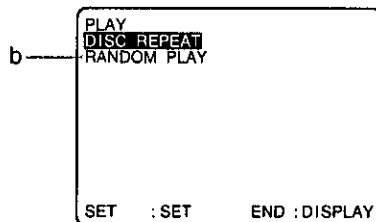

For your reference

• CHAPTER/TITLE REPEAT PLAY (DVD)

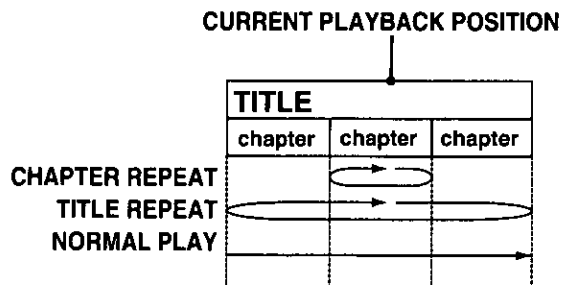

• TRACK/DISC REPEAT PLAY (Video CD/CD)

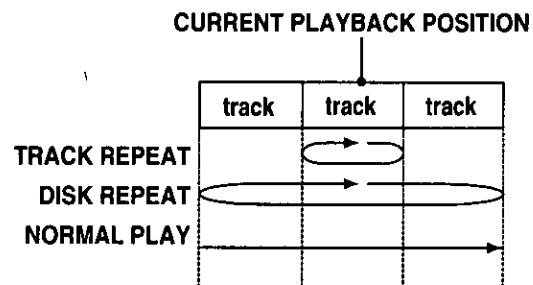

Note

- For repeat play in VCR mode, see page 42.

DVD Lock Feature

*Important: if a remote control button does not work when pressed, press the $\sqrt{\text{OFF}}$ DVD button on the remote and try the button again.

You can prevent playback of DVDs in a specific rating level which may be unsuitable for children.

- Some DVDs are encoded with a rating level. If the disc rating is higher (stricter) than the one you preset, playback will be prohibited.

Caution

Discs not encoded with rating level will play even if the jacket states it is for mature audiences. For these discs, the DVD Lock Ratings will not work.

Setup DVD Lock Ratings (DVD only)

Perform DVD Lock setting in TV mode.
Enter your secret code to display LOCK menu.
(Do "Enter Secret Code" steps on page 38.)

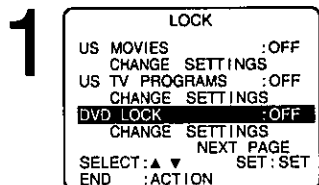

Select DVD LOCK.

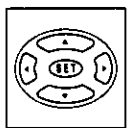

- 1) Press $\blacktriangle\blacktriangledown$ * to select.
- 2) Press SET to set "ON" or "OFF."

- "ON" → DVD Lock is activated.
- "OFF" → DVD Lock is deactivated.

Note

- "NEXT PAGE" is setup to CANADIAN V-Chip setting mode. "NEXT PAGE" cannot be used in the U.S.

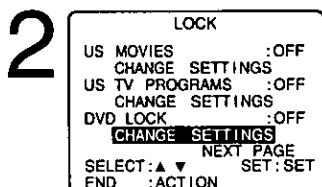

Select CHANGE SETTINGS.

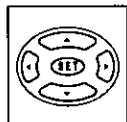

- 1) Press $\blacktriangle\blacktriangledown$ to select.
- 2) Press SET to display.

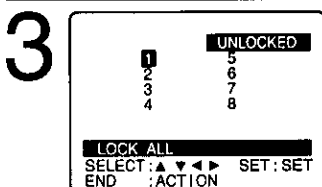

Select RATING LEVEL.

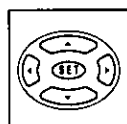

- 1) Press $\blacktriangle\blacktriangledown\blacktriangle\blacktriangledown$ to select.
- 2) Press SET to select "LOCKED" or "UNLOCKED."

LEVEL 1 : LOCK ALL :

Playback of all DVDs is prohibited. (Use to prohibit playback of adult DVDs not encoded with rating level information.)

LEVEL 2 : DVDs expressly for children can be played back.

LEVEL 3 to 7 :

DVDs for general audiences/children can be played back. (DVDs for adults are prohibited.)

LEVEL 8 : NO LIMIT :

All DVDs can be played back. (Factory preset)

- Ratings which are highlighted in Green will be blocked; those not highlighted (white letters) will not be blocked.

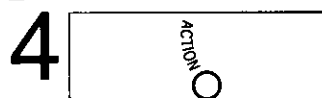

<Model PV-DF2700 button shown>

End setup.

Press ACTION three times.

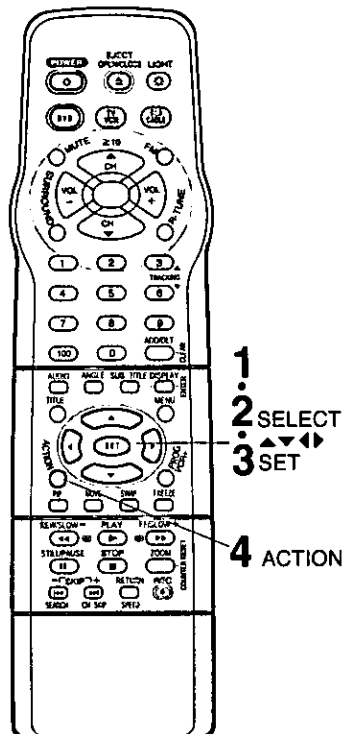

Model PV-DF2700 remote is shown here.

<When DVD Lock is activated>

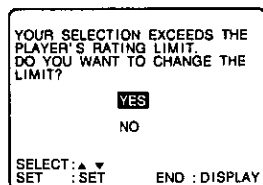

After DVD Lock is set and a blocked DVD is played, this message will appear.

The message may differ depending on the disc.

To continue viewing a blocked program for now,

Press $\blacktriangle\blacktriangledown$ to select "YES" and SET. Then, enter your 4 digit secret code. When "NO" is selected, blocked programs cannot be viewed.

To change the DVD LOCK settings, after entering your secret code in step 3 on page 38, select "OFF" to deactivate DVD Lock or change the rating level.

Settings for DVD Operation

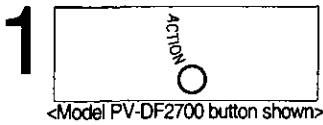

Display MAIN MENU.
Press ACTION in stop mode.

Once initial settings are done, they remain in memory (even after power off) until changed. This means the unit will always operate under the same conditions (especially DVDs) each time.

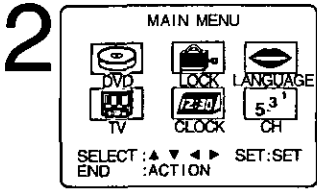

Display DVD screen.

- 1) Press \blacktriangle \blacktriangledown \blacktriangleleft \blacktriangleright to select.
- 2) Press SET.

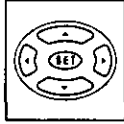

Check list before you begin.

- It is necessary, press TV to enter TV mode.



Select the desired item.

- 1) Press \blacktriangle \blacktriangledown to select.
- 2) Press SET.

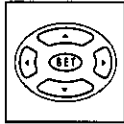

DISC LANGUAGES (See below)

All languages offered on the disc can be set. If the language set is not offered on the disc, the original disc language will be selected.

AUDIO OUTPUT (See page 60.)

You can set the audio output that comes from the digital audio output terminal.

STILL MODE (See page 61.)

To select "Field still" or "Frame still" to prevent jittering from occurring, or make small text or fine patterns clearly visible in a still picture. When AUTO is set "Field Still" or "Frame Still" is selected automatically.

TV MODE (See page 61.)

To select whether the video material for a wide-screen will be played back in the Pan & Scan style or in the Letterbox style on the screen.

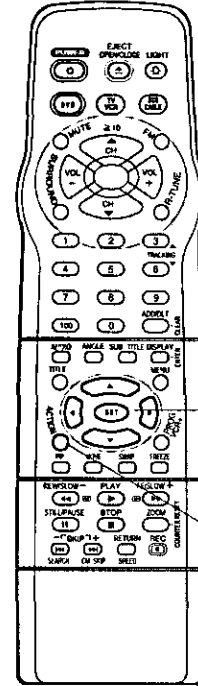

Model PV-DF2700 remote is shown here.

Selecting DISC LANGUAGES (DVD only)

To select and set the language of the audio soundtrack, subtitles, or title/DVD menus for all discs to be played.



Display DISC LANGUAGES screen.

- 1) Press \blacktriangle \blacktriangledown to select.
- 2) Press SET.

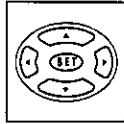

"AUDIO" selections

To select the audio soundtrack language.
English/French/Spanish (factory preset: English)
Original: Original disc language
OTHER ****: Other language selection**

"SUBTITLE" selections

To select the subtitle language.
AUTO: Same language selected for "AUDIO" (Factory preset)
• If language set for "AUDIO" is used in playback, subtitles will not appear.
• If another language is used during playback, the subtitles will appear in the language selected at "AUDIO" setup.

English/French/Spanish

OTHER ****: Other language selection**

"MENUS" selections

To select the language used in title menus or DVD menus.
English/French/Spanish (factory preset: English)
OTHER ****: Other language selection**

To enter OTHER **** code number, Press NUMBERED keys (Refer to the language codes on page 64).
To make corrections, press \blacktriangleleft repeatedly to delete language code number, and correct.

** If the selected language is not offered, the original disc language is selected.



Select the desired item.

- 1) Press \blacktriangle \blacktriangledown to select.
- 2) Press SET repeatedly for language. (Refer to the right.)

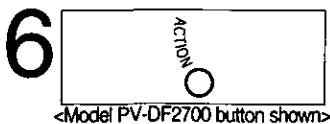
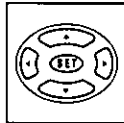

Redisplay DVD menu to continue setup.

Press ACTION and go to step 3 to setup another setting.

Or, to exit, press ACTION three times.

Settings for DVD Operation (continued)

Selecting AUDIO OUTPUT

Select the digital output to be output from the optical digital audio output connector of the unit.

1 Do steps 1 and 2 on page 59.



Display AUDIO OUTPUT screen.

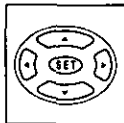

- 1) Press ▲▼ to select.
- 2) Press SET.

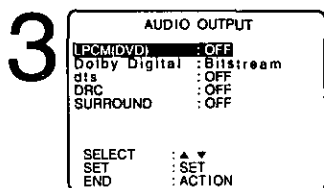

Select the desired item.

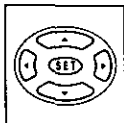

- 1) Press ▲▼ to select.
- 2) Press SET repeatedly for output.

■ "LPCM (DVD)" selections

OFF: Linear PCM of less than 48 kHz/16 bit is output. When playing DVDs recorded in linear PCM of over 48 kHz/20 bit or 96 kHz, no digital audio is output. (Factory preset)

PCM: When playing DVDs recorded in linear PCM of 48 kHz/20 bit/24 bit or 96 kHz, digital audio converted to 48 kHz/16 bit is output. (Digital output of PCM audio is restricted to 48 kHz/16 bit or below for copyright protection.)

■ "Dolby Digital" selections

Bitstream: Dolby Digital (AC-3) bitstream (2ch-5.1ch) is output. (Factory preset)

OFF: No output.

■ "dts" selections

Bitstream: dts bitstream is output. (Factory preset)

OFF: No output.

■ "DRC (Dynamic Range Compression)" selections

OFF: Normal audio range is selected. (Factory preset)

ON: For dynamic sound even at low volume, this is useful for late-night listening. [Dolby Digital (AC-3) DVDs only].

■ "SURROUND" selections

Surround Sound creates the effect of sound coming from nonexistent rear speakers even when only connected to a 2-channel stereo system.

OFF: No Surround Sound effect. (Factory preset)

ON: Surround Sound effect.

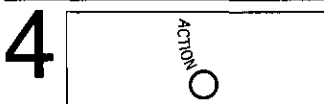

<Model PV-DF2700 button shown>

Redisplay DVD menu to continue setup.

Press ACTION and go to step 2 to setup another setting.

Or, to exit, press ACTION three times.

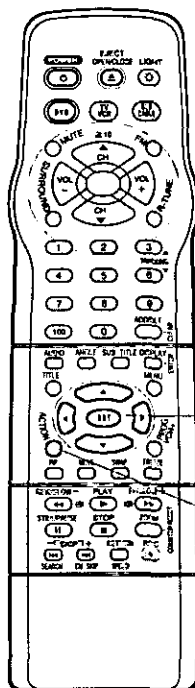

2 SELECT
3 ▲▼

4 ACTION

Model PV-DF2700 remote is shown here.

Type of amplifier to be connected	Recommended setting		
	LPCM (DVD)	Dolby Digital	dts
No amplifier is connected	OFF	OFF	OFF
AV amplifier (with digital audio input connector) without Dolby Digital/dts decoder	PCM*1	OFF*2	OFF*2
AV amplifier including Dolby Digital decoder	PCM*1	Bitstream	OFF
AV amplifier including Dolby Digital/dts decoder	PCM*1	Bitstream	Bitstream*3

* Make settings according to amplifier connected to optical audio output as shown in above table.

* When a dts decoder is not connected, to enjoy dts DVD, please select audio output other than dts at the dts DVD menu screen. Otherwise, there will be no sound from the unit speakers.

*1 Audio output from unit is converted to 48 kHz/16 bit in addition to audio from digital audio output. To enjoy high quality sound at 48 kHz/20 bit /24 bit or 96 kHz, connect the amplifier or decoder directly to the audio output connectors, not to the digital audio output connector. [Select "OFF" at the "LPCM (DVD)"]

*2 When connecting an amplifier (with an optical digital input connector) which does not contain the Dolby Digital (AC-3) or dts decoder, be sure to select "OFF". If "Bitstream" is selected, starting DVD play may cause such a high level of noise as to be harmful to your ears and damage the speakers.

*3 When a dts decoder is connected, please select "Bitstream" in "dts". If "OFF" is selected, there will be no sound.

Notes

- Turn off other surround effects when using this surround effect.
- For optimum effect, the distance between the unit and the listener should be about 3 or 4 times the distance between the right and left front speakers.

*Important: if a remote control button does not work when pressed, press the DVD button on the remote and try the button again.

Selecting STILL MODE

Set to reduce jitter in a displayed still picture or a motion picture.

1 Do steps 1 and 2 on page 59.



Set STILL MODE.

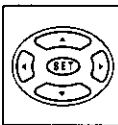

- 1) Press ▲▼ to select STILL MODE.
- 2) Press SET repeatedly to select setting.

AUTO: "Field still" or "Frame still" is automatically selected during the still mode. (Factory preset)

FIELD: "Field still" is always selected. Select this setting when jitter occurs in the picture even when "AUTO" is selected.

FRAME: "Frame still" is always selected. Select this setting when small text or fine patterns cannot be seen clearly even when "AUTO" is selected.

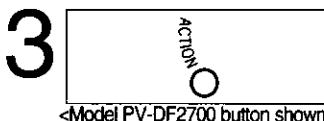

Exit this mode.
Press ACTION twice.

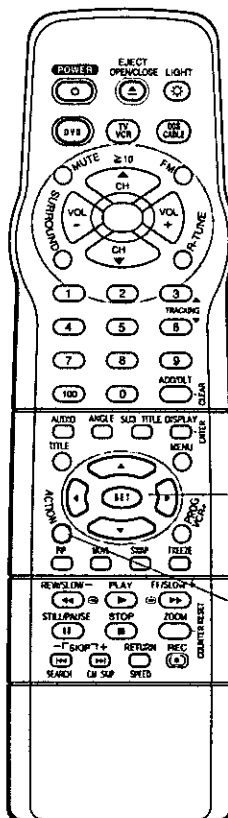

Model PV-DF2700 remote is shown here.

Selecting TV MODE

Set the screen display style for wide-screen video material playback.

a Do steps 1 and 2 on page 59.



Set TV MODE.

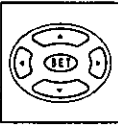

- 1) Press ▲▼ to select TV MODE.
- 2) Press SET repeatedly to select setting.

Pan & Scan : Wide screen video data is played in Pan & Scan style (left and right of screen is trimmed.) (Factory preset)

- Video data not formatted in Pan & Scan will play in letterbox style.

Letterbox : Wide screen video data is played in Letterbox style (top and bottom of screen has black margin).

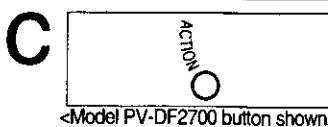

Exit this mode.
Press ACTION twice.

Example

- Pan & Scan (Factory preset)



- Letterbox



Before Requesting Service

Check the following points once again if you are having trouble with your unit.

Power	Correction
No power...	<ul style="list-style-type: none"> • Completely insert Power Plug into an AC outlet. • Set POWER button to ON.
Power turns itself off...	<ul style="list-style-type: none"> • Auto power-off (shutoff) occurs after about 5 min. in DVD mode with no operation, or if there is no broadcast signal in TV or Playback mode. Turn the power back on. (P.20, 44)
Monitor	Correction
No picture or sound...	<ul style="list-style-type: none"> • Make sure your antenna system (TV or CABLE), is correctly set. (P. 9) • Completely insert Power Plug into an AC outlet. • Set POWER button to ON.
Poor picture with normal sound...	<ul style="list-style-type: none"> • Adjust BRIGHTNESS, SHARPNESS, and PICTURE controls in the SET UP Video Adjustment. (P.48, 49)
Poor sound with normal picture...	<ul style="list-style-type: none"> • Adjust VOLUME control. (P.15)
Poor TV reception...	<ul style="list-style-type: none"> • Adjust SHARPNESS and PICTURE controls in the SET UP Video Adjustment. (P. 48, 49)
No color or poor color...	<ul style="list-style-type: none"> • Adjust TINT and COLOR controls in the SET UP Video Adjustment. (P.48, 49)
Ghost (multiple) images...	<ul style="list-style-type: none"> • Install a directional antenna.
TV programs cannot be watched...	<ul style="list-style-type: none"> • Make sure the selected channel is in unit's memory. (P.14)
Channel cannot be selected...	<ul style="list-style-type: none"> • Only the channel begin recorded can be viewed on this unit.
VCR	Correction
TV program cannot be recorded...	<ul style="list-style-type: none"> • Make sure your antenna system (TV or CABLE), is correctly set. (P. 9) • Make sure cassette record tab is intact. (P. 6)
Timer recording cannot be performed...	<ul style="list-style-type: none"> • Check that clock is set to current time and date. • Make sure DSS/CABLE box (if used) is left on and tuned to channel to be recorded. • Set recording Start/Stop times correctly. (P.22-23) • Timer recording may not be performed or continued if a power interruption of more than 1 minute occurs before or during a Timer Recording, even after power is restored.
No playback picture, or the playback picture is noisy or contains streaks...	<ul style="list-style-type: none"> • Adjust TRACKING control in either direction. (P.17) • Try Head Cleaning. (P.8)
VCR cannot be controlled...	<ul style="list-style-type: none"> • Make sure VCR LOCK is set to off. (P.45)
DVD/Video CD/CD	Correction
Play fails to start even when PLAY is pressed...	<ul style="list-style-type: none"> • This unit cannot play discs other than DVDs, Video CDs and CDs. • The disc may be dirty and require cleaning.
Play starts but then stops immediately...	<ul style="list-style-type: none"> • Be sure disc is installed with label side up.
Picture is distorted during rapid advance or rapid reverse...	<ul style="list-style-type: none"> • The picture will be somewhat distorted at times: this is normal.
No rapid advance (or rapid reverse) play...	<ul style="list-style-type: none"> • Some discs may have sections which prohibit rapid advance (or rapid reverse).
Play does not start even when title is selected...	<ul style="list-style-type: none"> • Confirm the "DVD LOCK" setting. (P.58)
Audio soundtrack and/or subtitle language is not the one selected at the initial settings...	<ul style="list-style-type: none"> • If the audio soundtrack and/or subtitle language selected at DVD initial settings does not exist on the disc, it will not be accessible.
No subtitles...	<ul style="list-style-type: none"> • Subtitles appear only when available on disc. • "OFF" is selected at the changing subtitle language. Select "ON" to display the subtitles. (P.50)
Alternative audio soundtrack (or subtitle) language cannot be selected...	<ul style="list-style-type: none"> • Alternative language cannot be selected with discs which do not contain more than one language. • For some discs, alternative language cannot be selected with the AUDIO or SUB TITLE button. Try selecting it from the DVD menu if available.
Angle cannot be changed...	<ul style="list-style-type: none"> • This function is dependent on software availability. Even if disc has multiple angles, they may be recorded for specific scenes only (ANGLE indicator on unit lights up). (P.51)

Remote Control	Correction
Unit cannot be controlled...	<ul style="list-style-type: none"> • Aim Remote directly at the remote sensor on the unit. (P.74) • Avoid any object blocking signal path. • Inspect the remote batteries. (P.6) • Make sure VCR LOCK is set to off. (P.45) • Exposing unit remote sensor to direct fluorescent or outdoor light may cause signal interference.
ACTION, PLAY, SELECT, SET POWER, etc. buttons cannot be selected...	<ul style="list-style-type: none"> • Press $\overline{\text{VCR}}$ for TV-VCR mode. (P.28) • Press DVD for DVD mode. (P.28) • Press FM for FM mode. (P.28) • Check remote batteries.
Miscellaneous	Correction
Video cassette cannot be inserted...	<ul style="list-style-type: none"> • Insert the cassette window side up; record tab facing you.
Video cassette cannot be removed...	<ul style="list-style-type: none"> • Completely insert Power Plug into an AC outlet.
Eject does not function or insertion cannot be done...	<ul style="list-style-type: none"> • Turn the POWER off and then on, and try ejecting or inserting the tape again.
Video cassette ejects when a recording is started, or the power is turned off for timer recording...	<ul style="list-style-type: none"> • Make sure cassette record tab is intact. (P.6)
The disc cannot be removed...	<ul style="list-style-type: none"> • First, turn the unit power off. Then, prepare a rigid wire (e.g. an extended paper clip, etc.) and, applying moderate force, insert it straight into the hole at the base of the tray. The tray will eject a little. Now, pull the tray all the way out and remove the disc. (P.73)
In Stop mode, the VCR motor (CYLINDER) continues to rotate...	<ul style="list-style-type: none"> • To enable Quick Play mechanism, the VCR cylinder will rotate for about 5 minutes. This reduces response time from Stop to Play mode and from Play to Rewind Search mode.

If you cannot resolve the problem, please call the Customer Satisfaction Center for product assistance at 201-348-9090.

To locate an authorized servicenter, please call toll free 1-800-211-PANA (7262.)

or send e-mail to : consumerproducts@panasonic.com

Warning and Instruction Displays

These displays will alert you of a missed operation or provide further instructions.

OSD	Caution	Page
NO CH FOUND PLEASE CHECK ANTENNA CABLE CONNECTION THEN PUSH CH UP KEY AGAIN	<ul style="list-style-type: none"> • If no active channels are found for CHANNEL MEMORY... 	9
PLEASE SET CLOCK BEFORE PROGRAMMING	<ul style="list-style-type: none"> • If you attempt to set or review a Timer Recording, VCR Plus+ System Programming or set the On-Timer and the Clock is not set... 	12, 13
CHECK CASSETTE RECORD TAB	<ul style="list-style-type: none"> • If you press REC, and a cassette is inserted with no record tab... 	6, 18
TO CANCEL TIMER REC HOLD DOWN STOP KEY FOR APPROX 3 SEC	<ul style="list-style-type: none"> • If you press STOP during a Timer Recording... 	23
NO CASSETTE PLEASE INSERT A CASSETTE	<ul style="list-style-type: none"> • If you press PLAY, FF, REW, or REC without a cassette inserted... 	17, 18
PLEASE PREPARE FOR TIMER REC	<ul style="list-style-type: none"> • If the unit is not in Stop mode or a cassette with record tab is not inserted two minutes before a Timer Recording is about to begin... 	22, 23
VIDEO HEADS MAY NEED CLEANING PLEASE INSERT HEAD CLEANING CASSETTE OR REFER TO MANUAL END: PLAY KEY	<ul style="list-style-type: none"> • If head cleaning becomes necessary while playing back a tape... 	8
VCR LOCK ACTIVATED	<ul style="list-style-type: none"> • If you press a function button other than STOP/EJECT or POWER while the unit is in VCR Lock mode... 	45
PLEASE CHECK THE DISC, AND FOR STAINS OR SCRATCHES ON DISC	<ul style="list-style-type: none"> • If you press PLAY, or the unit reads data from a stained or scratched disc in DVD mode. Also, if the type of disc is other than DVD, Video CD or CD... 	7
IT IS PROHIBITED TO COPY DVD/ VIDEO CD/CD TO VHS	<ul style="list-style-type: none"> • If you press REC in DVD mode... 	18

Language Code List

Enter the appropriate code number for the initial settings "AUDIO", "SUBTITLE" and/or "MENU" (see page 59).

Code	Language	Code	Language	Code	Language	Code	Language
6565	Afar	7079	Faroese	7678	Lingala	8375	Slovak
6566	Abkhazian	7082	French	7679	Laothian	8376	Slovenian
6570	Afrikaans	7089	Frisian	7684	Lithuanian	8377	Samoan
6577	Ameharic	7165	Irish	7686	Latvian, Lettish	8378	Shona
6582	Arabic	7168	Scots Gaelic	7771	Malagasy	8379	Somali
6583	Assamese	7176	Galician	7773	Maori	8381	Albanian
6588	Aymara	7178	Guarani	7775	Macedonian	8382	Serbian
6590	Azerbaijani	7185	Gujarati	7776	Malayalam	8385	Sundanese
6665	Bashkir	7265	Hausa	7778	Mongolian	8386	Swedish
6669	Byelorussian	7273	Hindi	7779	Moldavian	8387	Swahili
6671	Bulgarian	7282	Croatian	7782	Marathi	8465	Tamil
6672	Bihari	7285	Hungarian	7783	Malay	8469	Telugu
6678	Bengali; Bangla	7289	Armenian	7784	Maltese	8471	Tajik
6679	Tibetan	7365	Interlingua	7789	Burmese	8472	Thai
6682	Breton	7378	Indonesian	7865	Nauru	8473	Tigrinya
6765	Catalan	7383	Icelandic	7869	Nepali	8475	Turkmen
6779	Corsican	7384	Italian	7876	Dutch	8476	Tagalog
6783	Czech	7387	Hebrew	7879	Norwegian	8479	Tonga
6789	Welsh	7465	Japanese	7982	Oriya	8482	Turkish
6865	Danish	7473	Yiddish	8065	Panjabi	8484	Tatar
6869	German	7487	Javanese	8076	Polish	8487	Twi
6890	Bhutani	7565	Georgian	8083	Pashto, Pushto	8575	Ukrainian
6976	Greek	7575	Kazakh	8084	Portuguese	8582	Urdu
6978	English	7576	Greenlandic	8185	Quechua	8590	Uzbek
6979	Esperanto	7577	Cambodian	8277	Rhaeto-Romance	8673	Vietnamese
6983	Spanish	7578	Kannada	8279	Romanian	8679	Volapük
6984	Estonian	7579	Korean	8285	Russian	8779	Wolof
6985	Basque	7583	Kashmiri	8365	Sanskrit	8872	Xhosa
7065	Persian	7585	Kurdish	8368	Sindhi	8979	Yoruba
7073	Finnish	7589	Kirghiz	8372	Serbo-Croatian	9072	Chinese
7074	Fiji	7665	Latin	8373	Singhalese	9085	Zulu

Spanish Quick Use Guide/Guía para rápida consulta

Conexión de la antena externa

Desenganche la antena del televisor o de la videograbadora que tuviera anteriormente y conéctela a la parte trasera del registrador Combinación de VCR/TV, como se muestra en el diagrama. Si el sistema de su antena tiene conductores UHF y VHF separados, usted necesita un mezclador de banda UHF/VHF (no viene con el equipo.)

ADVERTENCIA:

Al utilizar cables coaxiales RF del "Tipo tuerca", solo debe apretarse con los dedos. Si se aprieta demasiado los cables pueden resultar dañados.

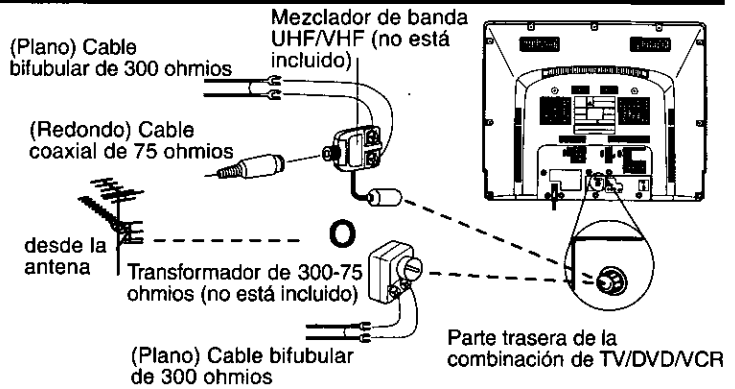

Conexiones de TV cable

■ Sin un decodificador de TV cable

Podrá;

- grabar o ver canales sin codificar.

No Podrá;

- grabar o ver canales codificados.
- ver otro canal que no sea el seleccionado para cualquier tipo de grabación.

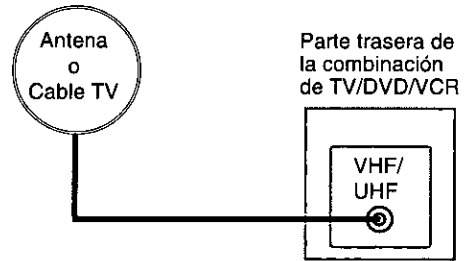

■ Con un decodificador de TV cable

Podrá;

- grabar o ver cualquier canal incluso los canales codificados.

NOTA : El canal deberá ser seleccionado en el decodificador de TV cable.

No Podrá;

- ver otro canal que no sea el seleccionado para cualquier tipo de grabación.
- hacer una grabación con temporizador de un canal a menos que lo seleccione en el decodificador de TV cable.

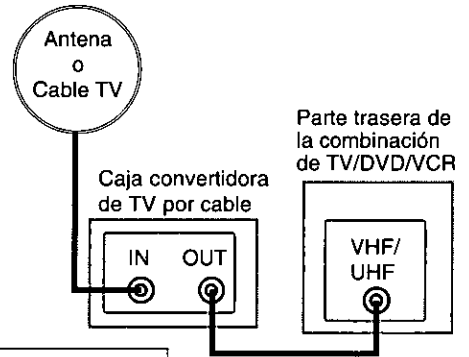

Para ver y grabar un canal codificado/ no codificado

Sintonice el canal del Registrador de la combinación de VCR/TV en el canal de salida de la caja convertidora de televisión por cable (por ejemplo el canal 3.) Después, seleccione en el decodificador de TV cable el canal que se quiera ver o grabar.

■ Con un receptor DSS

Podrá;

- grabar o ver cualquier canal incluso los canales codificados.

NOTA : El canal deberá ser seleccionado en el receptor DSS.

No Podrá;

- ver otro canal que no sea el seleccionado para cualquier tipo de grabación.
- hacer una grabación con temporizador de un canal a menos que lo seleccione en el receptor DSS.

NOTA : El receptor DSS debe estar apagado para ver programas desde un decodificador de TV cable o desde la antena.

Consulte el manual del receptor DSS para más detalles.

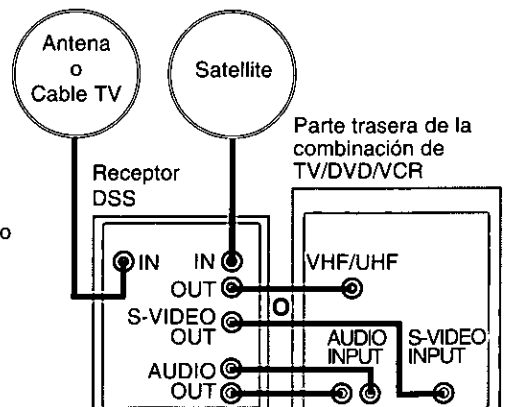

Para fijar el idioma, canal y reloj

1 Presione **POWER** para encender el videograbador combinado.

2

SELECT LANGUAGE

PUSH CH ▲ :English
OPRIMIR CH ▼ :Español
APP. VOL + :Français

Seleccione el lenguaje.

CH : para inglés

CH : para español

VOL+: para francés

3

FIJACION AUTO. (CA/RELOJ)

CONECTE EL CABLE DE LA ANTENA Y SI ESTA USANDO UNA CAJA DE TV POR CABLE SINTONICE AL CANAL PBS DE SU LOCAL LUEGO...

POR FAVOR OPRIMIR CH UP

Comience el ajuste automático de canales y el ajuste automático del reloj.

Presione CH ▲.

Las siguientes informaciones aparecerán seguidamente:

- AUTOPROGRAMACION EN PROCESO
- AUTOPROGRAMACION COMPLETO
- FIJACION AUTOMATICA DEL RELOJ EN PROCESO

6/7/2000 MIE 12:00PM
HORA VERANIEGA: ACT
CANAL FIJADO : CA 10

FIJACION AUTOMATICA
COMPLETO

TERMINAR : OPRIMIR CH UP

(Ajuste terminado)

Presione CH ▲ para salir.

• Si la hora exhibida no es la correcta para su zona, ajuste el reloj nuevamente de acuerdo con la sección "Ajuste de la zona horaria" en la siguiente página.

Caso 1

FIJACION AUTOMATICA DEL RELOJ ES INCOMPLETO

OPRIMIR ACTION PARA FIJAR EL RELOJ

(Ajuste sin terminar)

NOTA IMPORTANTE PARA AJUSTE AUTOMATICO DEL RELOJ

- El ajuste automático del reloj será realizado al volver a encender el videograbador combinado cada vez que lo apague. Si usa un decodificador de TV cable y desea que la función de ajuste automático del reloj funcione, el decodificador de TV cable debe quedar encendido y sintonizando el canal PBS en el momento en que se apaga el videograbador combinado.
- Si usa un sintonizador de TV satelital, para que funcione el ajuste automático del reloj, debe de estar apagado.
- Si usa un toma de audio/video para conectar el videograbador combinado y el decodificador de TV cable o el sintonizador de TV satelital, deberá también conectar el cable coaxial RF para poder usar las funciones de ajuste automático de reloj y ajuste automático de canal.
- Si por cualquier razón se cambiara la hora manualmente, no se podrá realizar la corrección automática de la hora.

Caso 1 El ajuste del reloj es incompleto. Ajuste el reloj manualmente.

a

FIJACION AUTOMATICA DEL RELOJ ES INCOMPLETO

OPRIMIR ACTION PARA FIJAR EL RELOJ

Exhiba la pantalla **FIJAR RELOJ.** Presione **ACTION** para salir de este modo.

b

FIJAR RELOJ

VERANO: ACT

ELEGIR MES

ELEGIR: ▲ ▼

FIJAR : SET

TERMINAR: ACTION

Ajuste el reloj manualmente.

- 1) Presione ▲▼ para seleccionar el mes.
- 2) Presione SET para ajustar.

• De la misma manera, ajuste el día, el año, la hora y la hora de ahorro de energía. (VERANO)

Para hacer correcciones, presione repetidamente ◀▶ para moverse hasta el error, luego corríjalo.

C Final del ajuste. Presione dos veces **ACTION**.

Ajuste de la zona horaria

A Exhiba el **MENU PRINCIPAL.** Presione **ACTION**.

B

MENU PRINCIPAL

DVD BLOQUEO IDIOMA

TV RELOJ CANAL

ELEGIR : ▲ ▼ ◀ ▶

FIJAR: SET

TERMINAR: ACTION

Exhiba la pantalla "FIJAR RELOJ."

- 1) Presione ▲▼◀▶ para seleccionar "RELOJ."
- 2) Presione SET para exhibirla.

C

FIJAR RELOJ

FIJACION AUTOMATICA MANUAL

AJUSTE ZONA HORA : 0

ELEGIR: ▲ ▼

FIJAR : ◀ ▶

TERMINAR: ACTION

Seleccione "AJUSTE ZONA HORA."

- 1) Presione ▲▼ para seleccionar.
- 2) Presione ◀▶ para ajustar.

D Final del ajuste. Presione **ACTION** dos veces.

• El valor numérico ajustado aquí se vuelve "0" una vez que ajuste manualmente el reloj.

Para fijar o fijar de nuevo el reloj

En caso de que el reloj es incorrecto o ha ocurrido un corte eléctrico.

- 1 Oprima **ACTION** para que parezca el **MENU PRINCIPAL**.
- 2 Oprima ▲▼◀▶ para elegir "RELOJ." Luego, oprima **SET** para que aparezca la pantalla de la **FIJAR RELOJ**.
- 3 Oprima ▲▼ para elegir "MANUAL," y luego **SET** para que aparezca la pantalla de la **FIJAR RELOJ**.
- 4 Por favor continúe con los pasos **b** y **c** de la instrucción anterior (Caso 1.)

Operaciones básicas para la reproducción

- 1 Inserte un casete.**
 - El videograbador combinado se enciende automáticamente.
- 2 Presione PLAY.**
 - La reproducción comienza automáticamente si el casete no tiene la lengüeta para prevención de grabación.
 - Para encontrar una escena en particular
 - Búsqueda hacia adelante → Presione FF
 - Búsqueda hacia atrás → Presione REW
 - Para ver una imagen fija (congelada) → Presione PAUSE/SLOW
 - Para ver en cámara lenta → Presione SLOW+ o SLOW- en el modo de imagen fija
 - Para ver imágenes cuadro a cuadro → Presione PAUSE/SLOW en el modo de imagen fija
 - Para parar → Presione STOP
 - Para rebobinar la cinta → Presione REW
 - Para hacer avanzar la cinta rápidamente → Presione FF
 - Para expulsar la cinta → Presione EJECT en el control remoto o STOP/EJECT en el videograbador combinado

Operaciones básicas para la grabación

- 1 Inserte un casete con la lengüeta para prevención de grabado.**
 - El videograbador combinado se enciende automáticamente.
- 2 Seleccione el canal.**

Presione CH ▲▼ o las teclas numéricas correspondiente.
- 3 Seleccione la velocidad de grabación.**

Presione SPEED.

SP = reproducción normal
 LP = reproducción larga
 SLP = reproducción super larga

 - La velocidad seleccionada debe aparecer en la pantalla.
- 4 Comience la grabación.**

Presione REC.

 - Para editar partes no deseadas de una grabación, presione PAUSE/SLOW para hacer una pausa durante la grabación.
 - No podrá ver otro canal durante la grabación.
 - Para parar → Presione STOP.
 - **El videograbador combinado deja de grabar a una hora prefijada.** (Grabación de un toque)
 Presione REC repetidamente para ajustar la hora de grabación (30 min - 4 horas.)

Grabación con temporizador

- 1 Exhiba FIJAR PROGRAMACION.**

Presione PROG/VCR+.
- 2 Exhiba TEMPORIZADOR.**

Presione ▲▼ para seleccionar.

Presione SET para exhibir.

 - Si ya existe un programa en la memoria, presione ▲▼ y SET para seleccionar un número de programa sin usar.
- 3 Ajuste la fecha de grabación.**

Presione ▲▼ para seleccionar.

Presione SET o ◀▶ para ajustar.

• 1 - 31 = Grabación única
 • DIARIO = a la misma hora de lunes a viernes
 • SEMANAL = a la misma hora una vez a la semana

Fecha de hoy — 7 — 8 — 9 — ... — 31 — 1 — 2 — ... — 6 — DIARIO

▲/▼ Orden para elegir SEMANAL (SAB) — SEMANAL (LUN) — SEMANAL (DOM)

Repita el paso 3 para ajustar: hora de comienzo, hora de parada, canal (o LINEA para una fuente exterior), velocidad (SP, LP, SLP)
- 4 Termine el programa.**

Presione PROG/VCR+ Para introducir más programas.

presione ▲▼ y SET para seleccionar y ajustar el número de programa en blanco, y luego repita los pasos 3.
- 5 Salga de este modo.**

Presione PROG/VCR+ dos veces

 - Si está usando un decodificador de TV cable, asegúrese que se encuentra en el canal deseado y que la alimentación queda conectada para grabar con temporizador.
 - El indicador PROG TIMER se enciende en el videograbador combinado.

Operaciones básicas del DVD

- 1** Presione **POWER** en el control remoto o el aparato.

- 2** Elija el modo **DVD**
Presione **DVD**.

- 3** **Introducir un disco.**
 - 1) Presione **OPEN/CLOSE**.
 - 2) Ponga un disco en la bandeja de disco.
 - Sujete el disco sin tocar ninguna de sus superficies, póngalo con el lado donde está impreso el título hacia arriba, alínelo con las guías y póngalo en su posición apropiada.

Disco de 3"(8 cm) Disco de 5" (12 cm)

- 4** **Iniciar la reproducción**
Presione **PLAY**.
La bandeja del disco se cierra automáticamente.
 - Si está usando un DVD interactivo (Interactive DVD) o un Vídeo CD con control de reproducción (playback control) y aparece un menú de títulos (**TITLE MENU**) en la pantalla, siga al paso 5.

- 5** **Elija el artículo deseado.**
 - 1) Presione **▲▼◀▶** o las teclas numéricas.
 - 2) Presione **SET** para la reproducción.

Si usa las teclas numéricas, la reproducción comienza automáticamente.

- 6** **Parar la reproducción.**
Presione **STOP**.

- 7** **Expulsar el disco.**
Presione **OPEN/CLOSE**.

- **Para buscar una escena particular**
Búsqueda hacia adelante →
Presione **FF** en el modo de reproducción.
Búsqueda hacia atrás →
Presione **REW** en el modo de reproducción.
(Para liberar, presione **PLAY**)
- **Para saltar un capítulo o una pista**
Salto hacia adelante →
Presione **SKIP ▶▶▶** en el modo de reproducción.
Un capítulo (DVD) o una pista (Vídeo CD/CD) se salta cada vez que se oprime la tecla.
Salto hacia atrás →
Presione **◀◀◀ SKIP** en el modo de reproducción.
- **Para ver una imagen fija**
Presione **PAUSE** durante la reproducción.
(Para liberar, presione **PLAY**)
- **Para ver imágenes cuadro a cuadro (DVD/Vídeo CD)**
La imagen avanza un cuadro cada vez que presiona la tecla.
Presione **PAUSE** en el modo de imagen fija.
(Para volver a la reproducción normal, presione **PLAY**.)
- **Para ver en cámara lenta (DVD/Vídeo CD)**
Presione **SLOW+** o **SLOW-** en el modo de imagen fija.
(Para liberar, presione **PLAY**)

Funcionamiento del DVD utilizando visualizaciones en pantalla

Cuando se pulsa **DISPLAY**, la visualización en pantalla muestra la información del disco (título / capítulo / número de pista, tiempo transcurrido de reproducción, audio / idioma del subtítulo, y ángulo) e información (repetir la reproducción, modo reproducción, Karaoke vocal e'ncendido / apagado, etc.).

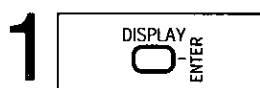

1 **Visualiza Visualizaciones en pantalla.**
Presione **DISPLAY** en el modo reproducción o parada.

• Cada vez que se presione **DISPLAY**, la visualización en pantalla cambia como se muestra a continuación.

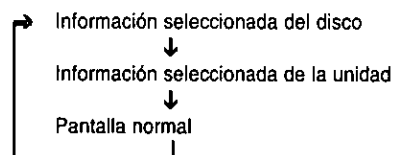

- 2** **Seleccio el ítem deseado**
 - 1) Presione **▲▼** (o **◀▶**) para seleccionar.
 - 2) Presione **SET** para ajustar

3 <Ejemplo de DVD>

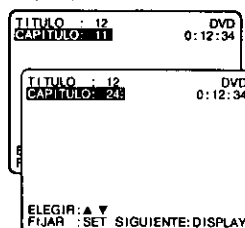

Seleccion el ajuste deseado

- 1) Presione **▲▼** para seleccionar.
- 2) Presione **SET** para ajustar.

Para volver a la pantalla normal,
Presione repetidamente **RETURN** o **DISPLAY**.

<Ejemplo de Vídeo CD>

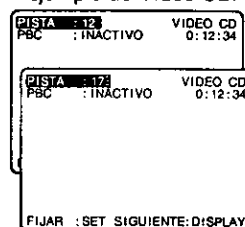

Cambio del idioma de subtítulos [DVD solamente]

El idioma de los subtítulos seleccionado al hacer las fijaciones iniciales se puede cambiar por otro idioma diferente, si éste se encuentra disponible.



1 Presione SUBTITLE durante la reproducción.

Cuando no haya subtítulos grabados, " " se visualizará en lugar del número de idioma.



2 Seleccionar el idioma deseado.

- 1) Presione ▲▼ para seleccionar idioma.
- 2) Presione ► (o ◀) para ajustar.
- 3) Presione ▲ (o ▼) para seleccionar "ON" o "OFF."

Para volver a la pantalla normal, Presione SUB TITLE.

Cambio del idioma de la pista de sonido [DVD solamente]

El idioma de la pista de sonido seleccionado al hacer las fijaciones iniciales se puede cambiar por otro idioma diferente, si éste se encuentra disponible.

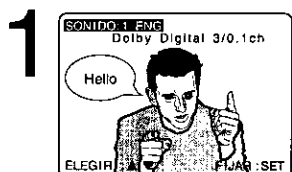

1 Visualizar la pantalla AUDIO.

Presione AUDIO durante la reproducción.

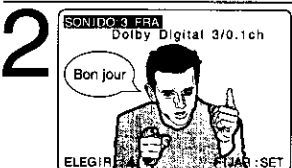

2 Seleccionar el idioma deseado.

Presione ▲▼ para seleccionar idioma.

Para volver a la pantalla normal, Presione AUDIO.

Visión desde otro ángulo [DVD solamente]

Algunos discos DVD tienen escenas que han sido filmadas simultáneamente desde un número de ángulos diferentes. Con estos discos, la misma escena podrá verse desde cada uno de estos ángulos diferentes utilizando el botón ANGLE.

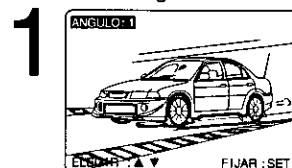

1 Visualizar la pantalla de ángulo.

Presione ANGLE durante la reproducción.

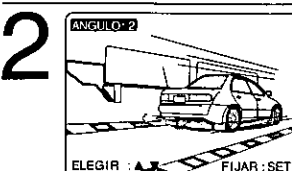

2 Seleccionar el ángulo deseado.

Presione ▲▼ para seleccionar.

Para volver a la pantalla normal, pulsar ANGLE.

Selección de vocal para los discos de Karaoke [DVD/Video CD]

1 Visualizar la pantalla AUDIO.

Presione AUDIO durante la reproducción.

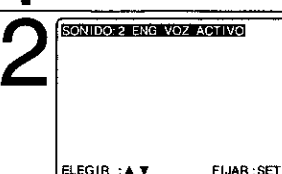

2 Seleccionar el ajuste deseado.

- 1) Presione ▲▼ (o ◀▶) para seleccionar.
- 2) Presione ► (o ◀) para ajustar. (DVD solamente)

- DVD Karaoke (1 vocal) VOCAL ON ↔ VOCAL OFF
 - DVD Karaoke (2 vocales) VOCAL V1 + V2 → VOCAL V1
 - Video CD VOCAL OFF ← VOCAL V2
- ↑ LR → L → R

Utilización de un menú de títulos [DVD solamente]

Algunos discos con películas, por ejemplo, vienen con dos o más títulos. Si el disco tiene un menú de títulos grabado, el botón TITLE podrá utilizarse para seleccionar el título de la película.

1 Presione TITLE durante la reproducción.

Ahora se visualiza una lista de los títulos del disco.

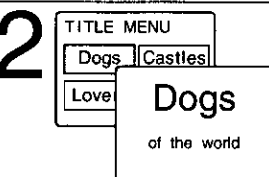

2 Seleccionar el título deseado.

- 1) Presione ▲▼◀▶ o la (s) tecla (s) NUMBERED para seleccionar.
- 2) Presione SET.

Utilización de un menú de DVD [DVD solamente]

Algunos discos DVD tienen estructuras únicas de menús llamadas menús DVD. por ejemplo, los DVDs programados con un contenido complejo proporcionan menús guía, y los grabados con varios idiomas proporcionan menús para audio e idiomas de subtítulos. Aunque los contenidos de los menús DVD y la operación cambian de disco a disco, a continuación se explica la operación básica cuando se utiliza esta característica.

1 Presione MENU durante la reproducción.

El menú de DVD introducido en el disco se visualiza ahora.

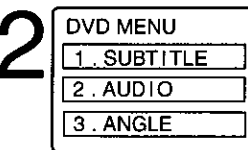

2 Seleccionar el ítem deseado.

- 1) Presione ▲▼◀▶ o la (s) tecla (s) NUMBERED para seleccionar.
- 2) Presione SET.

Ampliación de la imagen [DVD solamente]

Durante la reproducción de un DVD, puede ampliar partes específicas de una imagen y seleccionar la relación de zoom usando el botón ZOOM del mando a distancia.

Seleccione el tamaño de la imagen.

Presione ZOOM repetidamente para cambiar el tamaño de la imagen como se indica a continuación:

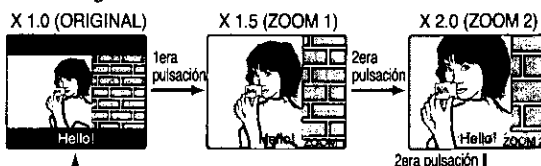

- Use los botones ▲ y ▼ para desplazar la posición hacia arriba o hacia abajo.
- Use los botones ◀ y ▶ para desplazar la posición hacia la izquierda o hacia la derecha.

Reproducción programada [Vídeo CD/CD]

Puede usted programar pistas específicas y el orden de reproducción.

• Vídeo CD o CD es insertado en el modo de DVD.

1 Visualizar MAIN MENU.

Presione ACTION en el modo parada.

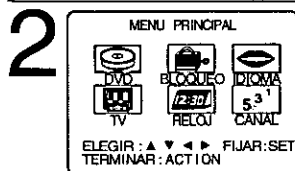

Visualizar la pantalla DVD.

- 1) Presione ▲▼◀▶ para seleccionar "DVD."
- 2) Presione SET para visualizar.



Seleccionar "MODO DE REPRODUCCION."

- 1) Presione ▲▼ para seleccionar.
- 2) Presione SET para visualizar.



Seleccionar "REPRODUCCION DE PROGRAMAS."

- 1) Presione ▲▼ para seleccionar.
- 2) Presione SET para visualizar.



Seleccionar el número de la pista deseada. (Se visualizan los números de la pista del disco).

- 1) Presione ▲▼◀▶ para seleccionar.
- 2) Presione SET para seleccionar.

- Repita el paso 5 para seleccionar otra pista.
- La pista seleccionada se añade a la parte derecha.



Comenzar "REPRODUCCION DE PROGRAMAS."

- 1) Presione ▲▼◀▶ para seleccionar "START."
- 2) Presione SET.

- La reproducción comienza en la secuencia programada.
- Para cancelar, pulsar STOP durante la reproducción y luego presione ADD/DLT.

Reproducción arbitraria [Vídeo CD/CD]

Las pistas se reproducen de forma arbitraria.

1 Repita los pasos 1-3 de la página anterior.



Seleccionar "REPRODUCCION ALEATORIA."

- 1) Presione ▲▼ para seleccionar.
- 2) Presione SET.

- Comienza la reproducción arbitraria.
- Para cancelar, presione STOP durante la reproducción y luego presione ADD/DLT.

Fijaciones iniciales

1 Visualizar MAIN MENU. Presione ACTION en el modo de parada.

2 Visualizar la pantalla DVD.

- 1) Presione ▲▼◀▶ para seleccionar.
- 2) Presione SET.

3 Seleccionar el artículo deseado.

- 1) Presione ▲▼ para seleccionar.
- 2) Presione SET.

IDIOMAS DEL DISCO

Todos los idiomas ofrecidos en el disco pueden ser ajustados. Si el idioma ajustado no es ofrecido en el disco, se seleccionará el idioma original del disco.

SALIDA DE AUDIO

Puede usted ajustar la salida audio procedente del terminal de salida audio digital.

DETENER RASTREO

Para seleccionar "Campo fijo" o "Cuadro fijo" para prevenir inestabilidad o para permitir ver textos pequeños o patrones finos claramente en el modo de imagen fija.

4 : 3 PREFERENCIA

Para seleccionar si el material del vídeo para pantalla ancha será vuelto a reproducir en el estilo Pan&Scan o en el estilo Letterbox en la pantalla.

4 Seleccionar el artículo deseado.

- 1) Presione ▲▼ para seleccionar.
- 2) Presione SET.

5 Volver a visualizar el menú de DVD para continuar el ajuste.

Presione ACTION y pase al paso 3 para ajustar otro ajuste o, para salir, presione ACTION tres veces.

Selección de IDIOMAS DEL DISCO [DVD solamente]

Seleccione "AUDIO"

Inglés / Francés / Español : (Fijación de fábrica : inglés)

Original : Se seleccionará el idioma original de cada disco.

OTRO **** : Se puede seleccionar el otro idioma.

Seleccione "SUBTITULO"

AUTO : Se seleccionará el mismo que fue seleccionado en la preparación de "AUDIO". (Fijación de fábrica)

- Si el idioma seleccionado en la preparación de "AUDIO" se utiliza durante la reproducción, los subtítulos no aparecerán.

- Si se utiliza otro idioma durante la reproducción, los subtítulos aparecerán en el idioma seleccionado en la preparación de "AUDIO"

Inglés / Francés / Español

OTRO **** : Se puede seleccionar el otro idioma.

Seleccione "MENU"

Inglés / Francés / Español : (Fijación de fábrica : inglés)

OTRO **** : Se puede seleccionar el otro idioma.

Selección de SALIDA DE AUDIO

Seleccione "LPCM(DVD)"

INACTIVO: Por el conector de salida de audio digital solamente sale PCM lineal de 48 kHz/16 bits. Durante la reproducción del DVD grabado en el PCM lineal de 48 kHz/20 bits/24 bits o 96 kHz, no sale audio digital. (Fijación de fábrica)

PCM: Durante la reproducción del DVD grabado en el PCM lineal de 48 kHz/20 bits/24 bits o 96 kHz, sale audio digital convertido a 48 kHz/16 bits. (La salida digital de audio PCM está restringida a 48 kHz/16bits o menos para proteger los derechos de autor.)

Seleccione "Dolby Digital"

Bitstream: Sale un flujo de bits Dolby digital (AC-3) (2ch-5.1ch). (Fijación de fábrica)

PCM: Sale PCM(2ch) de 48 kHz/16 bits.

Seleccione "dts"

INACTIVO: No salida.

Bitstream: Sale un flujo de bits dts. (Fijación de fábrica)

Seleccione "Dynamic Range Compression"

INACTIVO: Se selecciona el margen de audio normal. (Fijación de fábrica)

ACTIVO: Seleccione este ajuste para disfrutar de un sonido dinámico incluso a bajo volumen. Esto es muy útil para escuchar tarde durante la noche. [Esta función sólo se activa con DVDs Dolby Digital (AC-3).]

Seleccione "SURROUND"

El sonido envolvente virtual crea el efecto de sonido procedente de altavoces que parece que estén en la parte de atrás incluso cuando ha conectado sólo a un sistema estereo de 2 canales. [Sólo Dolby Digital (AC-3) DVD].

INACTIVO: No efecto de sonido envolvente virtual (Fijación de fábrica)

ACTIVO: Efecto de sonido envolvente virtual

Selección de DETENER RASTREO

AUTO: Durante el modo de imagen fija se seleccionarán automáticamente "Campo fijo" o "Cuadro fijo" (Fijación de fábrica)

CAMPO: Seleccione este ajuste cuando ocurra "distorsión" en las imágenes, incluso cuando se haya seleccionado "AUTO".

CUADRO: "Cuadro fijo" es siempre seleccionado. Seleccione este ajuste cuando no se puedan ver claramente texto pequeño o patrones finos incluso cuando esté seleccionado "AUTO".

Selección de 4 : 3 PREFERENCIA

Pan&Scan: Datos de la pantalla ancha de vídeo son reproducidos en el estilo Pan & Scan (la parte derecha e izquierda de la pantalla son recortadas). (Fijación de fábrica)

- Datos de vídeo no formateados en Pan & Scan serán reproducidos en el estilo letterbox.

Letterbox: Datos de la pantalla ancha de vídeo son reproducidos en el estilo Letterbox (la parte de arriba y abajo de la pantalla tienen un margen negro).

Picture in Picture (imagen superpuesta) (PIP) [PV-DF2700 solamente]

La función de visualización Picture in Picture (PIP) le permite ver dos imágenes simultáneamente.

Pantalla de visualización Picture in Picture (PIP)

A Seleccione PIP.
Presione PIP.



La pantalla PIP aparece sobre la pantalla de la imagen principal.

Para volver a la pantalla principal, presione PIP.

- La fuente de la imagen principal y la fuente de la imagen PIP pueden visualizarse al mismo tiempo. (Fuentes posibles: TV1 o TV2, DVD, VCR, LINE1 o LINE2).
- En el modo PIP, seleccione un canal y ajuste el volumen de la imagen principal solamente. Para seleccionar el canal y el nivel de volumen de la imagen PIP, primero presione SWAP para cambiar de la imagen PIP a la imagen principal; luego, seleccione el canal y el nivel de volumen.

Mover pantalla (MOVE)

Puede mover la pantalla PIP a cuatro posiciones diferentes. Seleccione la posición de la pantalla PIP. Presione MOVE repetidamente para seleccionar la posición de la pantalla PIP.

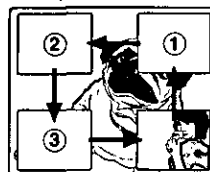

Posición inicial

Posición inicial

Cambiar de imagen (SWAP)

Puede cambiar la fuente de la imagen PIP y de la imagen principal. Cambie la fuente de imagen. Presione SWAP.



Congelar la imagen en modo PIP (FREEZE)

Puede crear una imagen PIP estática de la imagen principal. Congele la imagen principal. Presione FREEZE.



Imagen estática

Cambie la imagen PIP estática a una imagen en movimiento. Presione FREEZE.

• Mientras visualiza la imagen PIP, cada vez que presione el botón FREEZE, la imagen PIP cambiará entre una imagen estática y una en movimiento. Para cancelar la imagen PIP, presione el botón PIP.

Location of Controls

Remote Control Buttons

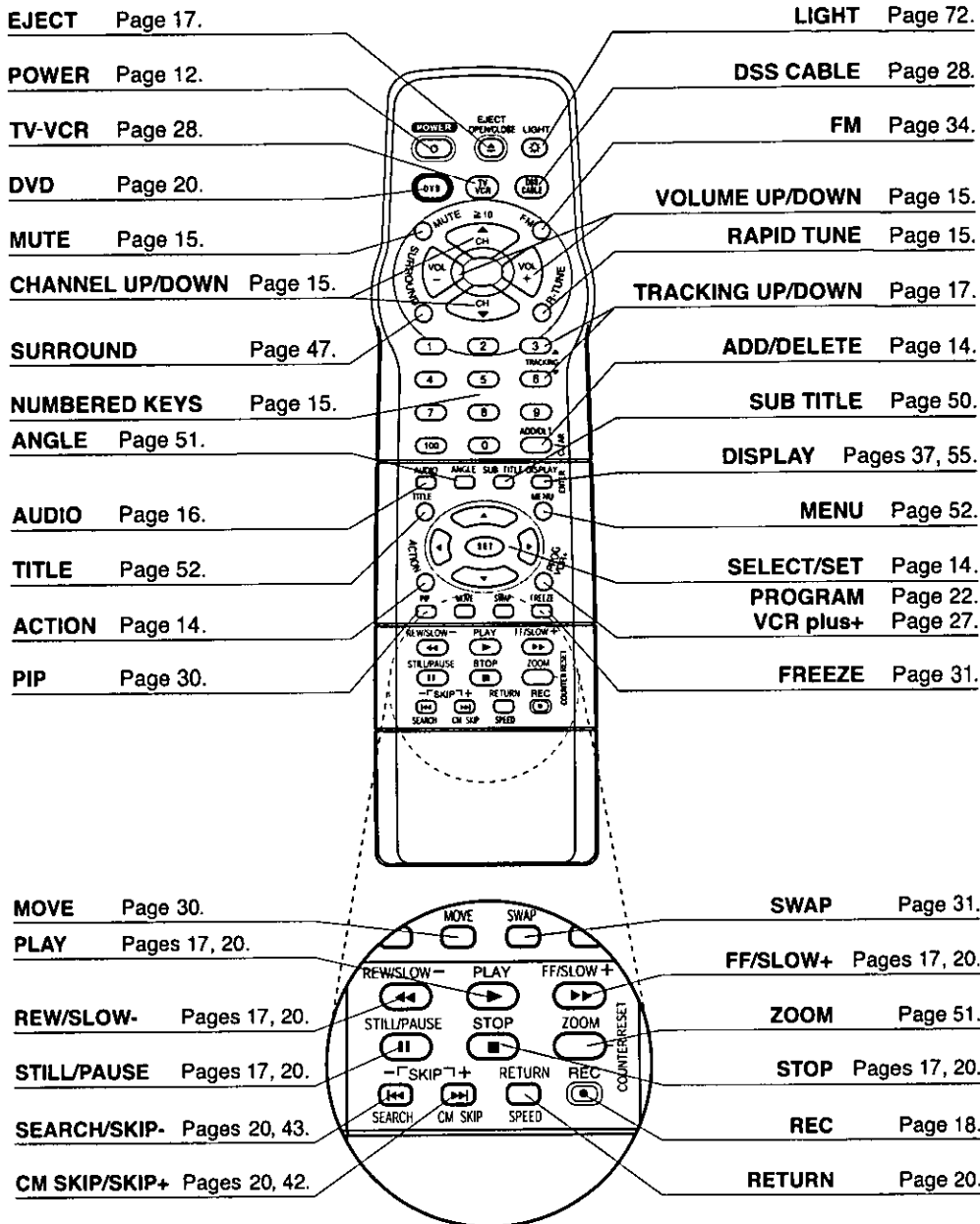

<Model PV-DF2700 remote is shown here.>

Universal Light Tower® Illuminated Remote Control

LIGHT button:

When LIGHT is pressed, (DVD, TV, DSS/CABLE, CH UP/DOWN, VOL UP/DOWN) buttons will light for 5 seconds for easy button location.

If no button is pressed in 5 seconds, the light goes out to conserve the battery.

EJECT button:

When this button is pressed in TV-VCR mode, the tape is ejected.

This button is inoperative if pressed during recording.

If pressed in DVD mode, the disc tray opens or closes.

Front View of the unit

If the disc cannot be removed, first, turn the unit power off. Then, prepare a rigid wire (e.g. an extended paper clip, etc.) and, applying moderate force, insert it straight into the hole at the base of the tray. The tray will eject a little. Now, pull the tray all the way out and remove the disc.

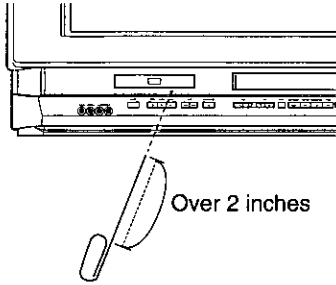

Built In Speaker (X 2)

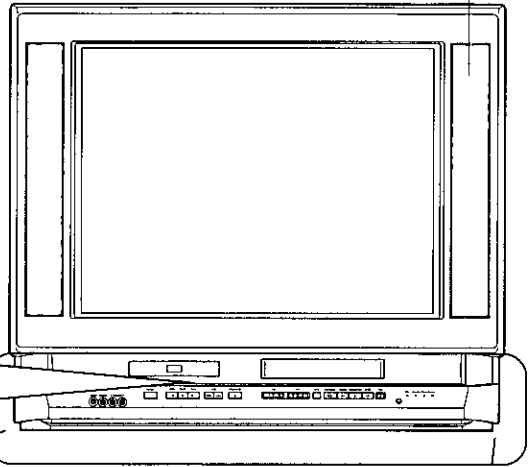

Disc Tray
See Page 20.

Cassette Compartment
See Pages 17, 18.

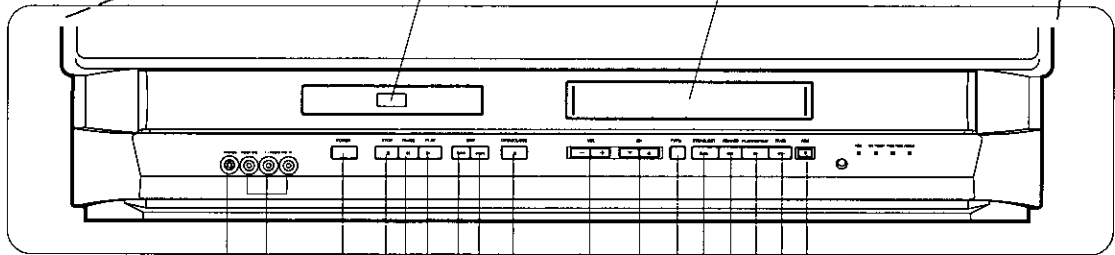

Phones Jack
See page 15.

Audio/Video
Input Connector 2 (LINE 2)
See pages 19, 24.

POWER
See page 12.

STOP
See page 20.

PAUSE
See page 20.

PLAY
See page 20.

SKIP ◀◀
See page 20.

SKIP ▶▶
See page 20.

OPEN/CLOSE
See page 20.

REC
See page 18.

FAST FORWARD/SEARCH
See page 17.

PLAY/REPEAT
See page 17.

REWIND/SEARCH
See page 17.

STOP/EJECT
See page 17.

TV/FM
See page 34.

CHANNEL UP/DOWN
TRACKING UP/DOWN
See page 15.

VOLUME UP/DOWN
See page 15.

For Your Information

Location of Controls

Indicators on the Front Panel

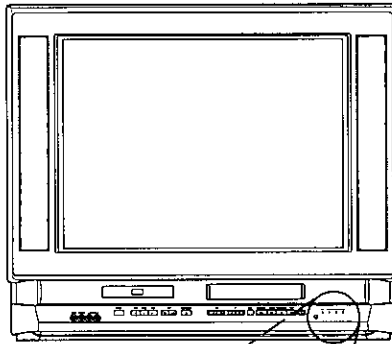

REC Indicator (RED)
Lights during recording. In Rec Pause or OTR Pause mode, the indicator flashes. See page 18.

Remote Sensor

ON TIMER Indicator (ORANGE)
Lights when the On Timer is set. See page 36.

ANGLE Indicator (RED)
Lights when a scene recorded at different angles is detected. See page 51. (DVD only).

PROG TIMER Indicator (GREEN)
Lights when the unit is set for Timer Recording. It flashes when a Timer Recording has been set with no tape inserted, the clock is not set, or the tape is in motion. See page 23.

Rear View of the unit

Audio Output Connector (L/R)
See page 10.

VHF/UHF Antenna Input Terminal
See page 9.

AC Power Plug

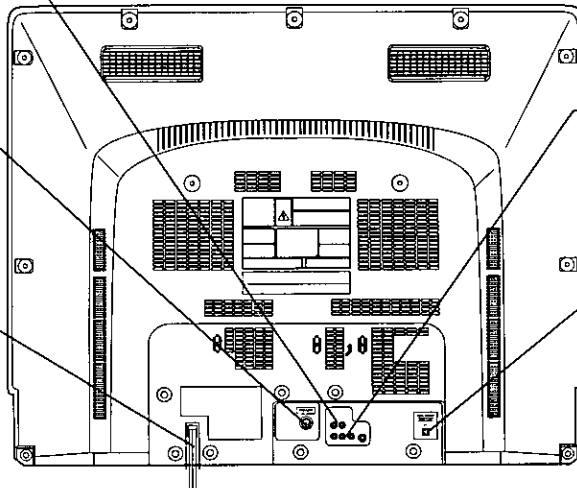

Audio/Video Input Connector 1 (LINE 1)
See pages 19, 24.

Optical digital audio output connector
See page 11.

Service Center List

For Product Information, Operating Assistance, Literature Request, Dealer Locations, and all Customer Service inquiries please contact:

1-800-211-PANA (7262), Monday-Friday 9 am-9 pm Saturday-Sunday 9 am-7 pm, EST.
or send e-mail to : consumerproducts@panasonic.com

Web Site: <http://www.panasonic.com>
You can purchase parts, accessories
or locate your nearest servicenter by
visiting our Web Site.

Accessory Purchases:

1-800-332-5368 (Customer Orders Only)

Panasonic Services Company 20421 84th Avenue South, Kent, WA 98032

(6 am to 5 pm Monday - Friday; 6 am to 10:30 am Saturday; PST)

(Visa, MasterCard, Discover Card, American Express, Check)

Factory Servicenters Locations

CALIFORNIA

6550 Katella Avenue
Cypress, CA 90630

800 Dubuque Avenue
S. San Francisco,
CA 94080

20201 Sherman Way
Suite 102
Canoga Park, CA 91306

3878 Ruffin Road
Suite A
San Diego, CA 92123

COLORADO

1640 South Abilene
Street Suite D
Aurora, CO 80012

FLORIDA

3700 North 29th Avenue
Suite 102
Hollywood, FL 33020

GEORGIA

8655 Roswell Road
Suite 100
Atlanta, GA 30350

ILLINOIS

9060 Golf Road
Niles, IL 60714

1703 North Randall
Road Elgin, IL 60123
(Pick-up / Drop-off only)

MARYLAND

62 Mountain Road
Glen Burnie, MD 21061

MASSACHUSETTS

60 Glacier Drive
Suite G
Westwood, MA 02090

MICHIGAN

37048 Van Dyke
Avenue
Sterling Heights,
MI 48312

MINNESOTA

7850-12th Avenue South
Airport Business Center
Bloomington, MN 55425

OHIO

2236 Waycross Road
Civic Center Plaza
Forest Park, OH 45240

PENNSYLVANIA

2221 Cabot Blvd
West Suite B
Langhorne, PA 19047

TEXAS

13615 Welch Road
Suite 101
Farmers Branch,
TX 75244

WASHINGTON

20425-84th Avenue
South Kent, WA 98032

HAWAII

99-859 Iwaiwa Street
Aiea, Hawaii 96701
Phone (808) 488-1996
Fax (808) 486-4369

Service in Puerto Rico

Matsushita Electric of Puerto Rico, Inc. Panasonic Sales Company/ Factory Servicenter:

Ave. 65 de Infanteria, Km. 9.5, San Gabriel Industrial Park, Carolina, Puerto Rico 00985

Phone (787)750-4300 Fax (787)768-2910

As of May 2000

Limited Warranty

Panasonic Consumer Electronics Company,
Division of Matsushita Electric Corporation of America,
One Panasonic Way
Secaucus, New Jersey 07094

Panasonic Sales Company,
Division of Matsushita Electric of Puerto Rico, Inc.
AVE. 65 de Infantería, Km. 9.5 San Gabriel
Industrial Park Carolina, Puerto Rico 00985

PANASONIC Video Products Limited Warranty

Panasonic Consumer Electronics Company or Panasonic Sales Company (collectively referred to as "the Warrantor") will repair this product with new or refurbished parts, free of charge, in the USA or Puerto Rico, in the event of a defect in materials or workmanship as follows (all time periods commence from the date of the original purchase):

PRODUCT	PARTS	LABOR	SERVICE	CONTACT NUMBER
CAMCORDER	ONE (1) YEAR, EXCEPT CCD IMAGE SENSOR	NINETY (90) DAYS	Carry-In or Mail In	1-800-211-PANA(7262)
	CCD IMAGE SENSOR - SIX (6) MONTHS	NINETY (90) DAYS		
VCR	ONE (1) YEAR	NINETY (90) DAYS	Carry-In or Mail In	1-800-211-PANA(7262)
AV MIXER	ONE (1) YEAR	NINETY (90) DAYS	Carry-In or Mail In	1-800-211-PANA(7262)
MONITOR- VCR/DVD Combination	ONE (1) YEAR, EXCEPT CRT CRT - TWO (2) YEARS	NINETY (90) DAYS CRT - NINETY (90) DAYS	Carry-In: 21" CRT and Smaller	1-800-211-PANA(7262)
			In-home or carry-in: 22" CRT and Larger	

Batteries (if included) - New rechargeable batteries in exchange for defective rechargeable batteries for ten (10) days. Non-rechargeable batteries are not warranted.

Tap (if included) - New video cassette tape in exchange for a defective video cassette tape for five (5) days.

In-home, carry-in or mail-in service, as applicable, in the USA can be obtained during the warranty period by contacting a Panasonic Services Company (PASC) Factory Servicenter listed in the Service Directory. Or call toll free contact number listed above, to locate an authorized PASC Servicenter. Carry-in or mail-in service in Puerto Rico can be obtained during the warranty period by calling the Panasonic Sales Company telephone number listed in the Servicenter Directory.

This warranty is extended only to the original purchaser. A purchase receipt or other proof of the date of the original purchase is required before warranty service is rendered.

This warranty only covers failures due to defects in materials and workmanship which occur during normal use and does not cover normal maintenance, including, but not limited to, video and audio head cleaning. The warranty does not cover damage which occurs in shipment, or failures which are caused by products not supplied by the warrantor, or failures which result from accident, misuse, abuse, neglect, mishandling, misapplication, alteration, modification, faulty installation, set-up adjustments, improper antenna, inadequate signal pickup, maladjustment of consumer controls, improper operation, power line surge, improper voltage supply, lightning damage, commercial use such as hotel, office, restaurant, or other business or rental use of the product, or service by anyone other than a PASC Factory Servicenter or a PASC authorized Servicenter, or damage that is attributable to acts of God.

LIMITS AND EXCLUSIONS

There are no express warranties except as listed above.

THE WARRANTOR SHALL NOT BE LIABLE FOR INCIDENTAL OR CONSEQUENTIAL DAMAGES (INCLUDING, WITHOUT LIMITATION, DAMAGE TO RECORDING MEDIA) RESULTING FROM THE USE OF THIS PRODUCTS, OR ARISING OUT OF ANY BREACH OF THE WARRANTY. ALL EXPRESS AND IMPLIED WARRANTIES, INCLUDING THE WARRANTIES OF MERCHANTABILITY AND FITNESS FOR PARTICULAR PURPOSE, ARE LIMITED TO THE APPLICABLE WARRANTY PERIOD SET FORTH ABOVE. Some states do not allow the exclusion or limitation of incidental or consequential damages, or limitations on how long an implied warranty lasts, so the above exclusions or limitations may not apply to you.

This warranty gives you specific legal rights and you may also have other rights which vary from state to state.

If a problem with this product develops during or after the warranty period, you may contact your dealer or Servicenter. If the problem is not handled to your satisfaction, then write to the Consumer Affairs Department at the Panasonic Consumer Electronics Company address above.

SERVICE CALLS WHICH DO NOT INVOLVE DEFECTIVE MATERIALS OR WORKMANSHIP AS DETERMINED BY THE WARRANTOR, IN ITS SOLE DISCRETION, ARE NOT COVERED. COSTS OF SUCH SERVICE CALLS ARE THE RESPONSIBILITY OF THE PURCHASER.

warvid 8/8/2000

Panasonic Consumer Electronics Company,
Division of Matsushita Electric Corporation of America
One Panasonic Way Secaucus,
New Jersey 07094

Panasonic Sales Company ("PSC"),
Division of Matsushita Electric of Puerto Rico, Inc.
Ave. 65 de Infantería, Km. 9.5
San Gabriel Industrial Park, Carolina,
Puerto Rico 00985



Printed in U.S.A.
LSQT0281A
S0900-0